

SUPEROFFERTA
2024



NON BESTEMMIARE



USAG XGRIP

Utensili per dadi e viti spanati.

€ Senza IVA 64/2024

Valida fino al 31/01/2025



SCOPRI LE NOVITÀ 2024



**Gamma X-Grip
Pagina 4**



**Arredamento da officina
Pagina 10**



**Banchi da lavoro
Pagina 14**



**Carrelli portautensili
Pagina 18**



**Assortimenti
Pagina 28**



**Valigie manutenzione
Pagina 32**



**Contenitori trasportabili
Pagina 34**



**Giraviti
Pagina 38**



**Inserti e chiavi maschio
Pagina 41**



**Pinze
Pagina 46**



**Chiavi di manovra
Pagina 51**



**Cricchetti e bussole
Pagina 56**



**Estrattori
Pagina 61**



**Serraggio controllato
Pagina 62**



**Forbici per elettricisti
Pagina 65**



**Elettrotecnica
Pagina 66**



**Idraulica
Pagina 68**



**Rivettatrici
Pagina 69**



**Manutenzione
Pagina 70**



**Illuminazione
Pagina 74**



**Autoriparazione
Pagina 76**



**Pneumatica e accessori
Pagina 84**



GAMMA UTENSILI X-GRIP

PERFETTA SU ESAGONI NUOVI, EFFICACE SU ESAGONI DANNEGGIATI.



VITI E DADI CON TESTA ESAGONALE



VITI CON ESAGONO INCASSATO



285 X



235 X



235 XL

IL PROFILO ESCLUSIVO X-GRIP
Solo USAG può darti un profilo che ti permette di svitare viti e dadi molto danneggiati.



280 HX



280 X



660 X

ANCHE PER ESAGONI PERFETTI
Se lavori su una vite o un dado intatti, il profilo X-Grip permette di trasmettere una coppia superiore rispetto ad un normale profilo e senza alcun danneggiamento.

CHIAVI COMBinate 285 X

FORCHETTA INCLINATA

Angolo di 15° rispetto all'asse della chiave.



SEZIONE A DOPPIA T

Massima resistenza alla flessione.

OCCHIO DISASSATO

Per dadi e bulloni incassati in posizioni di difficile accesso.

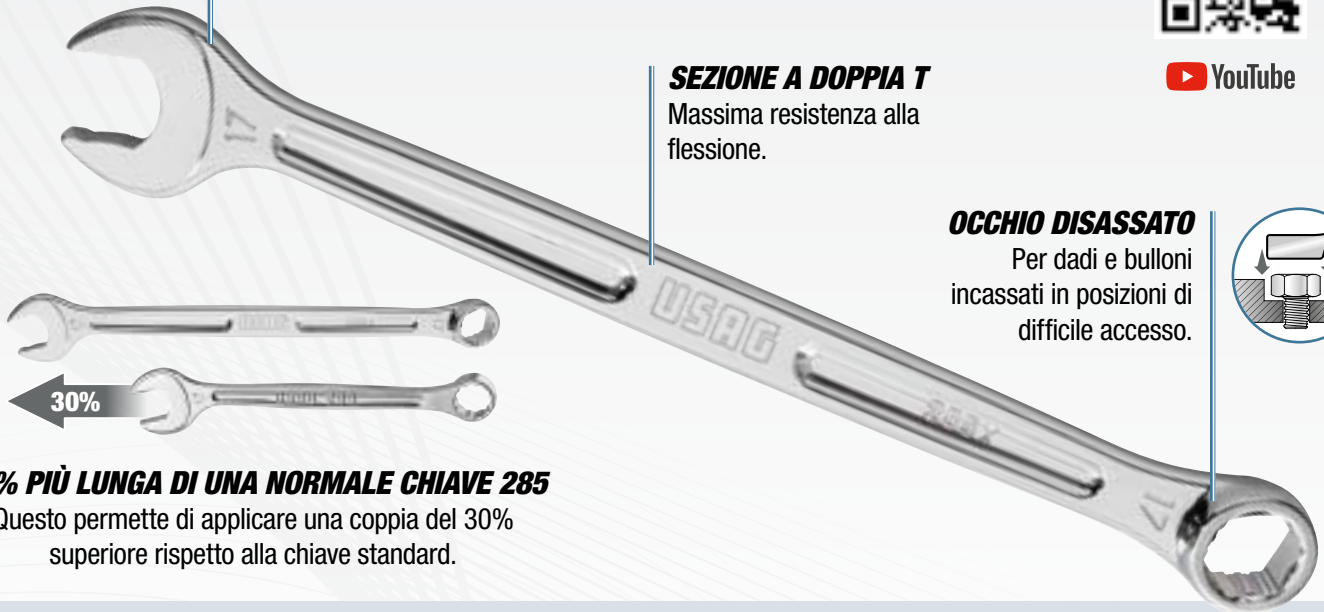
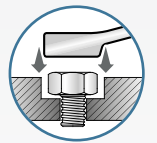

30% PIÙ LUNGA DI UNA NORMALE CHIAVE 285

Questo permette di applicare una coppia del 30% superiore rispetto alla chiave standard.

I VANTAGGI DEL PROFILO SPECIALE X-GRIP

- Presa perfetta su esagoni nuovi e danneggiati (fino all'80% utilizzando l'anello e 60% con la forchetta).
- Trasmette una coppia superiore rispetto a una bussola standard.
- Non danneggia gli esagoni nuovi.



8 PEZZI

285 X/B8
U02850950

Serie di 8 chiavi combinate

- 285 X/8-10-11-12-13-14-17-19 mm.
- Fornita in busta in tessuto in altissima resistenza.

8÷19 mm

~~€ 115,00~~

€ 79,00

12 PEZZI

285 X/B12
U02850951

Serie di 12 chiavi combinate

- 285 X/8-9-10-11-12-13-14-15-16-17-18-19 mm.
- Fornita in busta in tessuto in altissima resistenza.

8÷19 mm

~~€ 161,00~~

€ 113,00

BUSSOLE 235 X

ACCIAIO SPECIALE
altamente legato al
cromo vanadio.
Esecuzione cromata.



YouTube



I VANTAGGI DEL PROFILO SPECIALE X-GRIP

- Presa perfetta su esagoni nuovi e danneggiati fino all'80%.
- Trasmette una coppia superiore rispetto a una bussola standard.
- Non danneggia gli esagoni nuovi.



GUIDA MAGNETICA PORTABUSSOLE 559 A

- Disponibili nelle versioni con clip da 1/4", 3/8", 1/2".
- Base magnetica protetta da strato in gomma: non rovina la superficie.
- Clip orientabile a 360°, per identificare velocemente la bussola.



235 1/2" X/SE12
U02350501

12
PEZZI

1/2"

Serie di 12 chiavi a bussola
con bocca esagonale speciale

€ 115,00

€ 79,00

10-11-12-13-14-
15-16-17-18-19-
22-24 mm



235 1/4" X/SE10
U02350500

10
PEZZI

1/4"

Serie di 10 chiavi a bussola
con bocca esagonale speciale

€ 57,00

€ 39,00

5,5-6-7-8-9-10-
11-12-13-14 mm

ASSORTIMENTO CON INSERTI 660 X E BUSSOLE 235 X



23
PEZZI

1/4"

1/4"



Inserto
portabussole



609 1/4" SKX
U06090004

134 g | 120
30
mm | 60

Assortimento con bussole esagonali speciali ed inserti per avvitatura

- Cassetta in bimatereale con rivestimento soft-touch.
- Marcatura interna delle bussole contenute.
- Clip di aggancio in metallo.

DESCRIZIONE	ART./MISURA	PZ.
Cricchetto reversibile con prolunga	237 1/4" SK	2
Chiavi a bussola con bocca esagonale speciale	235 1/4" X 6-8-10-12-13	5
Inserti ad intaglio	660 0,5x4	1
Inserti a croce Phillips®	660 PH 2	1
Inserti a croce Pozidriv®- SUPadriv®	660 PZ 2	1
Inserto portabussole	660 Q 1/4"	1
Inserti TORX® Tamper Resistant	660 STX T20-T25-T30-T40	4
Inserti con profilo esagonale speciale	660 X 2-2,5-3-4-5-6-7-8	8

~~€ 137,00~~

€ 79,00

ASSORTIMENTO CON INSERTI 660 X



2-2,5-3-4-5-
6-7-8 mm



9
PEZZI



1/4" Bussola
portainseriti

660 X/B9
U06600100

110
20
mm | 105



YouTube

Set di inserti con profilo esagonale speciale

- Profilo esclusivo per esagoni incassati: permette di fare presa su esagoni incassati intatti o completamente danneggiati fino al 92%.
- In acciaio speciale con finitura fosfatata.
- Inclusa bussola portainseriti 1/4-1/4".
- Fornito in astuccio di tessuto compatto.

DESCRIZIONE	ART./MISURA	PZ.
Inserti con profilo speciale	660 X 2-2,5-3-4-5-6-7-8	8
Bussola portainseriti	684 1/4"	1

~~€ 55,50~~

€ 36,00

INSERTI 660 X

PROFILO ESCLUSIVO X-GRIP

Lo speciale design con cui sono realizzati gli inserti, permette di fare presa sugli esagoni incassati in qualunque condizione: intatti o completamente danneggiati.



VITI DANNEGGIATE

Quando una vite con esagono incassato si danneggia, non è più possibile svitarla con normali chiavi maschio esagonali. Gli inserti 660 X permettono di svitare anche viti danneggiate fino al 92% del profilo esagonale.



CHIAVI MASCHIO 280 X E 280 HX



PROFILO ESCLUSIVO X-GRIP

Lo speciale design con cui sono realizzate le chiavi, permette di fare presa sugli esagoni incassati in qualunque condizione: intatti o completamente danneggiati.



VITI DANNEGGIATE

Quando una vite con esagono incassato si danneggia, non è più possibile svitarla con normali chiavi maschio esagonali. Le chiavi 280 X e 280 HX permettono di svitare anche viti danneggiate fino al 92% del profilo esagonale.



6

PEZZI



YouTube

280 HX/SE6

U02802460

Serie di 6 chiavi maschio con profilo esagonale speciale e impugnatura bimatereale

- 280 HX/2,5-3-4-5-6-8 mm.
- Impugnatura ergonomica bimatereale con rivestimento antiscivolo.
- Design studiato per una presa sicura durante la manovra.
- Acciaio speciale altamente legato.
- Finitura zinco fosfatata per un'elevata resistenza alla corrosione.

~~€ 99,00~~

€ 69,00



9

PEZZI



YouTube

280 X/S9

U02800485

Set di 9 chiavi maschio con profilo esagonale speciale

- 280 X/1,5-2-2,5-3-4-5-6-8-10 mm.
- Modello che permette di operare con inclinazioni fino a 25% rispetto all'asse della vite.
- Acciaio speciale altamente legato.
- Finitura zinco fosfatata per un'elevata resistenza alla corrosione.
- Supporto in plastica.

~~€ 70,00~~

€ 49,00

X-GRIP NEL TUO CARRELLO!



XL



52
PEZZI

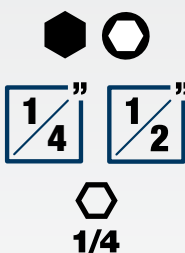

519 M 235X

U05191065

Modulo in spugna bicolor assortito

DESCRIZIONE	ART./MISURA	PZ.
Chiavi a bussola con bocca esagonale speciale	235 1/2 X10-11-12-13-14-15-16-17-18-19-22-24	12
Chiavi a bussola con bocca esagonale speciale	235 1/4 X 5,5-6-7-8-9-10-11-12-13-14	10
Chiavi a bussola lunghe con bocca esagonale speciale	235 1/2 XL 17-19-21	3
Prolunghe	236 1/2 125-250	2
Prolunghe	236 1/4 125-250	2
Cricchetto reversibile certificato IP51	237 A 1/2	1
Cricchetto reversibile certificato IP51	237 A 1/4	1
Leva a T con attacco quadro scorrevole	240 1/2 N	1
Leva a T con attacco quadro scorrevole	240 1/4	1
Snodo cardanico	241 1/2	1
Snodo cardanico	241 1/4	1
Set di 9 chiavi maschio con profilo esagonale speciale	280 X/S9 1,5-2-2,5-3-4-5-6-8-10	9
Inseriti con profilo esagonale speciale	660 X 2-2,5-3-4-5-6-7-8	8
Bussola portainseri	684 1/4	1

~~€ 506,00~~

€ 354,00



L



12
PEZZI



519 M 285X

U05191063

Modulo in spugna bicolor assortito

• 285 X/8-9-10-11-12-13-14-15-16-17-18-19 mm.

~~€ 171,00~~

€ 119,00



L



6
PEZZI

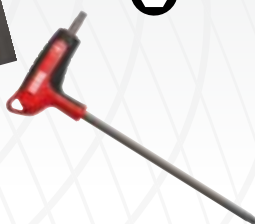

519 M 280HX

U05191064

Modulo in spugna bicolor assortito

• 280 HX/2,5-3-4-5-6-8 mm.

~~€ 111,00~~

€ 77,50

**Vuoi creare il tuo assortimento aggiungendo altri moduli?
Vai a pagina 31**

LINEA ARREDAMENTO START 516 LA TUA POSTAZIONE DI LAVORO PROFESSIONALE



YouTube

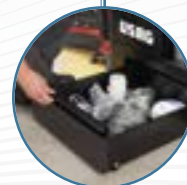

LA QUALITÀ DEI NOSTRI CARRELLI 516



Guide telescopiche da 35 mm
con portata fino a 40Kg.
Maniglie in ABS rinforzate.

PIANO DI LAVORO IN ACCIAIO O IN LEGNO AMPIO E RESISTENTE



Profondità utile: 600 mm.
Portata statica massima: 1000 Kg.

COMPATIBILE CON LA GAMMA MODULI



Puoi assortire carrello e cassettiere
utilizzando la gamma di moduli in
spugna ed in plastica.



**VUOI CREARE
LA TUA POSTAZIONE SU MISURA?**
Configurala su start516.usag.it

Include: ganci, lampade LED, presa multipla e cassetti su ruote



DESCRIZIONE	ART	PZ
Mobile fisso con 6 cassetti	516 SA/1T	1
Mobile fisso con 7 cassetti	516 SA1T/7	1
Carrello START - 6 cassetti (vuoto)	516 SA/16T	1
Mobile base con portarifiuti e portarotolo	516 SA17T	1
Cassetti su ruote per mobili base	516 SA20T	4
Pannello forato portautensili	516 SA5T	8
Pannello forato portautensili con 3 prese SCHUKO e 2 porte USB	516 SA6T	2
Armadio a 2 ante	516 SA3T/2	1
Armadio a 1 ante	516 SA/3T	1
Lampade a LED	516 SA/12	2
Pensili con anta basculante	516 SA/4T	5
Supporto per avvitatori	516 SA4TP	1
Rialzi per mobili	516 SA11T	6



516 SA/CTA
U05160299



502 kg



mm



± 2.000

650

Pianali in acciaio
1.450 mm - 516 AC/1
2.175 mm - 516 AC/2
Kit angolare
516 SA19T

Arredamento per officina - pianale in acciaio
• Fornita con kit base di 30 ganci 516 SA/K1.

~~€ 10.669,00~~

€ 7.469,00



516 SA/CTL
U05160300



502 kg



mm



± 2.000

650

Pianali in legno
1.450 mm - 516 SAL/1
2.175 mm - 516 SAL/2
Kit angolare
516 SA18T

Arredamento per officina - pianale in legno
• Fornita con kit base di 30 ganci 516 SA/K1.

~~€ 10.669,00~~

€ 7.469,00

2.100 mm 2.100 mm



Include: ganci, lampade LED, presa multipla e cassetti su ruote



DESCRIZIONE	ART	PZ
Mobile fisso con 7 cassetti	516 SA1T/7	1
Mobile fisso con 6 cassetti	516 SA/1T	1
Mobile fisso con 2 ante	516 SA/2T	1
Mobile base con portarifiuti e portarotolo	516 SA17T	1
Pannelli forati portautensili	516 SA5T	7
Pannello forato portautensili con 3 prese SCHUKO e 2 porte USB	516 SA6T	1
Pensili con anta basculante	516 SA/4T	4
Lampade a LED	516 SA/12	2
Cassetti su ruote per mobili base	516 SA20T	4
Kit di montaggio	516 SA14T	4
Rialzi per mobili	516 SA11T	4



516 SA/CBA
U05160297



529 kg



mm



± 2.000

650

Pianali in acciaio
2.175 mm
516 AC/2 (x2)
Kit angolare
516 SA19T

Arredamento per officina - pianale in acciaio
• Fornita con kit base di 30 ganci 516 SA/K1.

~~€ 6.564,00~~

€ 4.595,00



516 SA/CBL
U05160298



529 kg



mm



± 2.000

650

Pianali in legno
2.175 mm
516 SAL/2 (x2)
Kit angolare
516 SA18T

Arredamento per officina - pianale in legno
• Fornita con kit base di 30 ganci 516 SA/K1.

~~€ 6.564,00~~

€ 4.595,00



VUOI CREARE LA TUA Configurala su

**Include: ganci, lampade LED,
presa multipla e cassetti su ruote**

DESCRIZIONE	ART	PZ
Mobile fisso con 7 cassetti	516 SA1T/7	1
Mobile base con portarifiuti e portarotolo	516 SA1T/7	1
Pannelli forati portautensili	516 SA5T	5
Pannello forato portautensili con 3 prese SCHUKO e 2 porte USB	516 SA6T	1
Pensili con anta basculante	516 SA/4T	3
Armadio a 2 ante	516 SA3T/2	1
Carrello START - 6 cassetti (vuoto)	516 SA/16T	1
Supporto per avvitatori	516 SA4TP	1
Cassetti su ruote per mobili base	516 SA20T	2
Lampade a LED	516 SA/12	2
Kit di montaggio	516 SA14T	3
Rialzi per mobili	516 SA11T	3



516 SA/PRA
U05160295



342 kg



mm

↔ 3.175
↓ 2.000
↗ 650

Pianali in acciaio
2.175 mm - 516 AC/2

Arredamento per officina - pianale in acciaio
• Fornita con kit base di 30 ganci 516 SA/K1.

~~€ 5.982,00~~

€ 4.188,00



516 SA/PRL
U05160296



332 kg



mm

↔ 3.175
↓ 2.000
↗ 650

Pianali in legno
2.175 mm - 516 SAL/2

Arredamento per officina - pianale in legno
• Fornita con kit base di 30 ganci 516 SA/K1.

~~€ 5.982,00~~

€ 4.188,00



516 SA/STA
U05160293



295 kg



mm

↔ 2.675
↓ 2.000
↗ 650

Pianali in acciaio
2.175 mm - 516 AC/2

Arredamento per officina - pianale in acciaio
• Fornita con kit base di 30 ganci 516 SA/K1.

~~€ 5.407,00~~

€ 3.785,00



516 SA/STL
U05160294



284 kg



mm

↔ 2.675
↓ 2.000
↗ 650

Pianali in legno
2.175 mm - 516 SAL/2

Arredamento per officina - pianale in legno
• Fornita con kit base di 30 ganci 516 SA/K1.

~~€ 5.407,00~~

€ 3.785,00

**Include: ganci, lampade LED,
presa multipla e cassetti su ruote**

DESCRIZIONE	ART	PZ
Mobile fisso con 6 cassetti	516 SA/1T	1
Mobile fisso con 2 ante	516 SA/2T	1
Pannelli forati portautensili	516 SA5T	5
Pannello forato portautensili con 3 prese SCHUKO e 2 porte USB	516 SA6T	1
Pensili con anta basculante	516 SA/4T	3
Armadio a 1 anta	516 SA/3T	1
Carrello START - 6 cassetti (vuoto)	516 SA/16T	1
Cassetti su ruote per mobili base	516 SA20T	2
Lampade a LED	516 SA/12	2
Kit di montaggio	516 SA14T	3
Rialzi per mobili	516 SA11T	3



POSTAZIONE SU MISURA?

start516.usag.it



Include: ganci, lampade LED, presa multipla e cassetti su ruote

DESCRIZIONE	ART	PZ
Mobile fisso con 6 cassetti	516 SA/1T	1
Mobile fisso con 2 ante	516 SA/2T	1
Pannelli forati portautensili	516 SA5T	3
Pannello forato portautensili con 3 prese SCHUKO e 2 porte USB	516 SA6T	1
Pensili con anta basculante	516 SA/4T	2
Armadio a 1 anta	516 SA/3T	1
Cassetti su ruote per mobili base	516 SA20T	2
Kit di montaggio	516 SA14T	2
Rialzi per mobili	516 SA11T	3



516 SA/CA
U05160291



205 kg



1.450 mm



2.000 mm

650

Pianali in acciaio
1.450 mm - 516 AC/1

Arredamento per officina - pianale in acciaio

- Fornita con kit base di 30 ganci 516 SA/K1.

~~€ 4.140,00~~

€ 2.898,00



516 SA/CL
U05160292



197 kg



1.450 mm

650

Pianali in legno
1.450 mm - 516 SAL/1

Arredamento per officina - pianale in legno

- Fornita con kit base di 30 ganci 516 SA/K1.

~~€ 4.140,00~~

€ 2.898,00



DESCRIZIONE	ART	PZ
Mobile fisso con 6 cassetti	516 SA/1T	1
Mobile fisso con 2 ante	516 SA/2T	1
Carrello START - 6 cassetti (vuoto)	516 SA/16T	1
Rialzi per mobili	516 SA11T	2



516 SA/BCA
U05160289



200 kg



2.175 mm



817 mm

500

Pianali in acciaio
2.175 mm - 516 AC/2

Banco da lavoro - pianale in acciaio

~~€ 2.468,00~~

€ 1.728,00



516 SA/BCL
U05160290



188 kg



2.175 mm

500

Pianali in legno
2.175 mm - 516 SAL/2

Banco da lavoro - pianale in legno

~~€ 2.468,00~~

€ 1.728,00



SISTEMA BANCHI 506 RESISTENZA E STABILITÀ AL TOP



YouTube



ACCESSORI LATERALI

compatibile con la linea 516 AC
(solo modelli 506 KA e KL).



CASSETTI MAGGIORATI

montati su guide ad alte prestazioni.



MONTANTI IN LAMIERA

d'acciaio spessore 1,2 mm per la
massima resistenza.



Tutti i modelli sono disponibili con
piano di lavoro in acciaio spessore
3 mm o legno multistrato da 30 mm.



Tutti i modelli sono predisposti
con forature per essere fissati al
pavimento o affiancati tra loro.

2.000 kg



150 kg | 2.000 mm | 910 mm | 700 mm



2000 mm

ACCIAIO

2 CASSETTI

506 KA
U05060256

RAL 9005

Postazione di lavoro con piano in acciaio

- Piano di lavoro in lamiera d'acciaio zincata spessore 3 mm con bordi anticaduta da 37 mm.
- Struttura resistente a 6 montanti.
- Doppio cassetto ad estrazione totale con serratura.
- Ante in lamiera d'acciaio con cerniere regolabili.
- Ripiano interno in dotazione.
- Pannelli laterali con agganci per accessori linea 516.
- Predisposizione per il fissaggio a pavimento.
- Portata statica: 2000 Kg.
- Dimensioni interne cassetti: 830x550x110 mm.
- Dimensioni interne vano con ante: 860x350x440 mm
- Verniciato colore nero RAL 9005
- Consegnato smontato.

~~€ 1.555,00~~

€ 1.089,00

2.000 kg



140 kg | 2.000 mm | 910 mm | 700 mm



2000 mm

LEGNO

2 CASSETTI

506 KL
U05060246

RAL 9005

Postazione di lavoro con piano in legno

- Piano di lavoro in legno multistrato spessore 30 mm.
- Struttura resistente a 6 montanti.
- Doppio cassetto ad estrazione totale con serratura.
- Ante in lamiera d'acciaio con cerniere regolabili.
- Ripiano interno in dotazione.
- Pannelli laterali con agganci per accessori linea 516.
- Predisposizione per il fissaggio a pavimento.
- Portata statica: 2000 Kg.
- Dimensioni interne cassetti: 830x550x110 mm.
- Dimensioni interne vano con ante: 860x350x440 mm
- Verniciato colore nero RAL 9005
- Consegnato smontato.

~~€ 1.713,00~~

€ 1.199,00



506 TAC

RAL 9005

ACCIAIO

Banchi da lavoro con piano in acciaio

- Piano di lavoro in lamiera d'acciaio zincata spessore 3 mm con bordi anticaduta da 37 mm.
- Montanti e ripiano inferiore in lamiera d'acciaio spessore 1,2 mm.
- Fori laterali per il fissaggio di più banchi affiancati.
- Predisposizione per il fissaggio a pavimento.
- 6 montanti per il modello di lunghezza 2 metri.
- Spazio tra due montanti: 864 mm.
- Spazio tra il ripiano di appoggio ed il piano di lavoro: 525 mm.
- Dimensioni interne cassetti:
 - L 1000 e L 2000: 830x550x110 mm
 - L 1500: 1280x550x110 mm
- Consegnato smontato.

CODICE	DIMENSIONI LxPxH	PESO	N° cassetti		
U05060154	1046x700x910 mm	65 kg	1	€ 540,00	€ 378,00
U05060155	1500x700x910 mm	85 kg	1	€ 669,00	€ 468,00
U05060156	2000x700x910 mm	110 kg	2	€ 910,00	€ 637,00



506 TLC

RAL 9005

LEGNO

Banchi da lavoro con piano in legno

- Piano di lavoro in legno multistrato spessore 30 mm.
- Montanti e ripiano inferiore in lamiera d'acciaio spessore 1,2 mm.
- Fori laterali per il fissaggio di più banchi affiancati.
- Predisposizione per il fissaggio a pavimento.
- 6 montanti per il modello di lunghezza 2 metri.
- Spazio tra due montanti: 864 mm.
- Spazio tra il ripiano di appoggio ed il piano di lavoro: 525 mm.
- Dimensioni interne cassetti:
 - L 1000 e L 2000: 830x550x110 mm
 - L 1500: 1280x550x110 mm
- Consegnato smontato.

CODICE	DIMENSIONI LxPxH	PESO	N° cassetti		
U05060144	1046x700x910 mm	55 kg	1	€ 640,00	€ 448,00
U05060145	1500x700x910 mm	75 kg	1	€ 798,00	€ 559,00
U05060146	2000x700x910 mm	100 kg	2	€ 1.068,00	€ 748,00

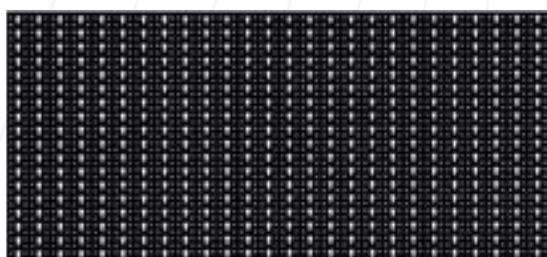

501 P

RAL 9005

Pannelli forati

- Diametro fori 5 mm.
- Lamiera di acciaio, spessore 1,2 mm.

CODICE	MIS	DIMENSIONI INT. LxPxH	PESO		
U05010103Q	C	1000x800x40mm	9,5 kg	€ 110,00	€ 77,00
U05010104Q	A	1500x800x40 mm	13,5 kg	€ 185,00	€ 129,00
U05010105Q	B	2000x800x40 mm	17,5 kg	€ 211,00	€ 148,00



506 TA

RAL 9005



Banchi da lavoro con piano in acciaio

- Piano di lavoro in lamiera d'acciaio zincata spessore 3 mm con bordi anticaduta da 37 mm.
- Montanti e ripiano inferiore in lamiera d'acciaio spessore 1,2 mm.
- Fori laterali per il fissaggio di più banchi affiancati.
- Predisposizione per il fissaggio a pavimento.
- 6 montanti per il modello di lunghezza 2 metri.
- Spazio tra due montanti: 864 mm.
- Spazio tra il ripiano di appoggio ed il piano di lavoro: 660 mm.
- Consegnato smontato.

CODICE	DIMENSIONI LxPxH	PESO		
U05060054	1046x700x910 mm	50 kg	€ 356,00	€ 249,00
U05060055	1500x700x910 mm	60 kg	€ 427,00	€ 299,00
U05060056	2000x700x910 mm	80 kg	€ 542,00	€ 379,00



506 TL

RAL 9005



Banchi da lavoro con piano in legno

- Piano di lavoro in legno multistrato spessore 30 mm.
- Montanti e ripiano inferiore in lamiera d'acciaio spessore 1,2 mm.
- Fori laterali per il fissaggio di più banchi affiancati.
- Predisposizione per il fissaggio a pavimento.
- 6 montanti per il modello di lunghezza 2 metri.
- Spazio tra due montanti: 864 mm.
- Spazio tra il ripiano di appoggio ed il piano di lavoro: 660 mm.
- Consegnato smontato.

CODICE	DIMENSIONI LxPxH	PESO		
U05060044	1046x700x910 mm	40 kg	€ 456,00	€ 319,00
U05060045	1500x700x910 mm	50 kg	€ 556,00	€ 389,00
U05060046	2000x700x910 mm	70 kg	€ 700,00	€ 490,00



506 TC

RAL 9005

Cassetti per banchi da lavoro

- Compatibili con banchi 506 TA e 506 TL.
- Guide telescopiche con resistenza al carico fino a 60 Kg.

CODICE	MIS	DIMENSIONI INT. LxPxH	PESO		
U05060154Q	1	830x550x110 mm	15 kg	€ 184,00	€ 129,00
U05060155Q	2	1280x550x110 mm	25 kg	€ 242,00	€ 169,00



CARRELLO 516 START RESISTENTE ED AFFIDABILE.



Piano di lavoro da 460 x 560 mm
con bordi anticaduta da 15 mm



Guide resistenti da 35 mm
con portata fino a 40 kg



Maniglie in ABS rinforzate
con apertura basculante



Risparmia il tuo tempo

Tutti i carrelli a cassetteria USAG sono subito pronti all'uso, perchè forniti con le ruote già montate alla struttura.



800 kg

5
CASSETTI

3
MODULI

54 kg | 779 mm | 972 mm | 515 mm

516 ST5V

U05160105

RAL 3020

Carrello START (vuoto)

- Dimensioni interne:
 - 2 cassetti 570x420x60 mm.
 - 2 cassetti 570x420x130 mm.
 - 1 cassetto 570x420x270 mm.

~~€ 649,00~~

€ 459,00



800 kg

6
CASSETTI

3
MODULI

55 kg | 779 mm | 972 mm | 515 mm

516 ST6V

U05160106

RAL 3020

Carrello START (vuoto)

516 ST6NV

U05160116

RAL 9005

Carrello START (vuoto)

- Dimensioni interne:
 - 3 cassetti 570x420x60 mm.
 - 2 cassetti 570x420x130 mm.
 - 1 cassetto 570x420x200 mm.

~~€ 715,00~~

€ 509,00



800 kg

7
CASSETTI

3
MODULI

56 kg | 779 mm | 972 mm | 515 mm

516 ST7V

U05160107

RAL 3020

Carrello START (vuoto)

516 ST7NV

U05160117

RAL 9005

Carrello START (vuoto)

- Dimensioni interne:
 - 5 cassetti 570x420x60 mm.
 - 1 cassetto 570x420x130 mm.
 - 1 cassetto 570x420x200 mm.

~~€ 781,00~~

€ 549,00



516 ST8V
U05160108

RAL 3020

Carrello START (vuoto)

- Dimensioni interne:
 - 6 cassetti 570x420x60 mm.
 - 2 cassetti 570x420x130 mm.

~~€ 847,00~~

€ 599,00



516 STXL6V
U05160146

RAL 3020

Carrello START (vuoto)

- Dimensioni interne:
 - 3 cassetti 760x420x60 mm.
 - 2 cassetti 760x420x130 mm.
 - 1 cassetto 760x420x200 mm.

~~€ 865,00~~

€ 599,00



516 STXL6NV
U05160156

RAL 9005

Carrello START (vuoto)

- Dimensioni interne:
 - 3 cassetti 760x420x60 mm.
 - 2 cassetti 760x420x130 mm.
 - 1 cassetto 760x420x200 mm.

~~€ 865,00~~

€ 599,00



Antiribaltamento



516 STS7V
U05160127

RAL 3020

Carrello START (vuoto)

- Dimensioni interne:
 - 5 cassetti 570x420x60 mm.
 - 1 cassetto 570x420x130 mm.
 - 1 cassetto 570x420x200 mm.

~~€ 915,00~~

€ 639,00



516 STS7NV
U05160137

RAL 9005

Carrello START (vuoto)

- Dimensioni interne:
 - 5 cassetti 570x420x60 mm.
 - 1 cassetto 570x420x130 mm.
 - 1 cassetto 570x420x200 mm.

~~€ 915,00~~

€ 639,00



516 STC4V
U05160104

RAL 3020

Cassettiera START (vuota)

- Dimensioni interne:
 - 3 cassetti: 570x420x60 mm.
 - 1 cassetto: 570x420x130 mm.

~~€ 500,00~~

€ 349,00

NON TROVI IL TUO Configuralo su



6 CASSETTI
3 MODULI

**RISPARMI
€ 150**

Rispetto all'acquisto di carrello ed assortimento separati.



6 CASSETTI
3 MODULI

**RISPARMI
€ 150**

Rispetto all'acquisto di carrello ed assortimento separati.

157 PEZZI

516 ST6PM
U05160630

RAL 3020



516 ST6NPM
U05161630

RAL 9005

Carrello START con assortimento MANUTENZIONE - 4 cassette

~~€ 1.949,00~~

€ 988,00

142 PEZZI

516 ST6PA
U05160629

RAL 3020



516 ST6NPA
U05161629

RAL 9005

Carrello START con assortimento AUTORIPARAZIONE - 2 cassette

~~€ 1.863,00~~

€ 988,00

ASSORTIMENTO MANUTENZIONE



519/613AEA 519/613CEA 519 SK692V 519/285A1 519/150AX 519 SK692V



519/324H 519/324TX 519 SK692V + 692 J32 519 SK692V 519/990A1 519/382F

ASSORTIMENTO AUTORIPARAZIONE



519/613AEA 519/613CEA 519 SK692V + 692 J32 519/324H 519/285A1 519/150AX

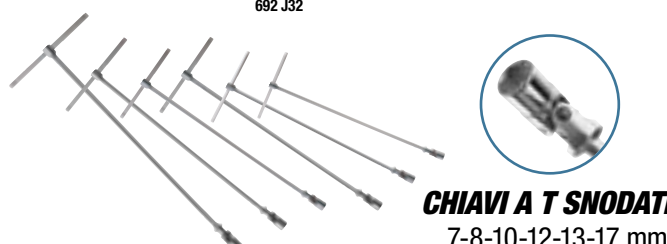

CHIAVI A T SNODATE
7-8-10-12-13-17 mm

DESCRIZIONE	ART	PZ
Bussole esagonali, cricchetto (237 A), accessori 1/4 ed inserti	519/613AEA	42
Bussole esagonali, cricchetto (237 A) ed accessori 1/2	519/613CEA	22
Chiavi combinate (6÷24 mm) + chiavi maschio esagonali (1,5÷10 mm)	519/285A1	25
Pinza universale, pinza regolabile, tronchese, pinza becchi lunghi e pinza grip	519/150AX	5
Giraviti per viti ad intaglio ed a croce PHILLIPS	519/324H	10
Giraviti per viti TORX	519/324TX	9
Lime a taglio mezzodolce	519/990A1	4
Martello per meccanici, mazzuola, cacciaspine, scalpello e bulino	519/382F	8
Assortimento di inserti con cricchetto reversibile	692 J32	32

DESCRIZIONE	ART	PZ
Bussole esagonali, cricchetto (237 A), accessori 1/4 ed inserti	519/613AEA	42
Bussole esagonali, cricchetto (237 A) ed accessori 1/2	519/613CEA	22
Giraviti per viti ad intaglio ed a croce PHILLIPS	519/324H	10
Chiavi combinate (6÷24 mm) + chiavi maschio esagonali (1,5÷10 mm)	519/285A1	25
Pinza universale, pinza regolabile, tronchese, pinza becchi lunghi e pinza grip	519/150AX	5
Chiavi a T snodate con bocca esagonale (7-8-10-12-13-17 mm)	276 CE	6
Assortimento di inserti con cricchetto reversibile	692 J32	32

Vuoi solo l'assortimento? Vai a pagina 29

ASSORTIMENTO IDEALE?

kitplanner.usag.it



6 CASSETTI 3 MODULI

RISPARMI
€ 220

Rispetto all'acquisto di carrello ed assortimento separati.



6 CASSETTI 3 MODULI

RISPARMI
€ 220

Rispetto all'acquisto di carrello ed assortimento separati.

156 PEZZI

516 ST6MM
U05160628

RAL 3020



516 ST6NMM
U05161628

RAL 9005

Carrello START con assortimento MANUTENZIONE - 4 cassetti

~~€ 2.187,00~~

€ 1.098,00

155 PEZZI

516 ST6MA
U05160627

RAL 3020



516 ST6NMA
U05161627

RAL 9005

Carrello START con assortimento AUTORIPARAZIONE - 3 cassetti

~~€ 2.171,00~~

€ 1.098,00

ASSORTIMENTO MANUTENZIONE



519 M 613AEA 519 M 613CEA 519 M 285A1



519 M 127C 519 M 150AX 519 MSK6



519 M 324H 519 M 324STX 519 MSK6+ 692 J32



519 M 990A5B 519 M 382 519 MSK6

DESCRIZIONE	ART	PZ
Bussole esagonali, cricchetto (237 A), accessori 1/4 ed inserti	519 M 613AEA	46
Bussole esagonali, cricchetto (237 A) ed accessori 1/2	519 M 613CEA	23
Chiavi combinate (6-7-8-9-10-1-12-13-14-15-16-17-18-19-22-24 mm)	519 M 285A1	17
Pinze per anelli elastici interni ed esterni 15÷25 e 19÷60	519 M 127C	6
Pinza universale, pinza regolabile, tronchese, pinza becchi lunghi e pinza grip	519 M 150AX	5
Giraviti per viti ad intaglio ed a croce PHILLIPS	519 M 324H	7
Giraviti per viti TORX	519 M 324STX	8
Lime a taglio mezzodolce	519 M 990A5B	5
Martello per meccanici, mazzuola, cacciaspine, scalpello e bulino	519 M 382F	7
Assortimento di inserti con cricchetto reversibile	692 J32	32

ASSORTIMENTO AUTORIPARAZIONE



519 M 285A1 519 M 324H 519 M 324STX



519 M 613AEA 519 M 612CLA



519 M 276C



CHIAVI A T SNODATE
8-10-13-17 mm

DESCRIZIONE	ART	PZ
Bussole esagonali, cricchetto (237 A), accessori 1/4 ed inserti	519 M 613AEA	46
Bussole esagonali lunghe e corte, cricchetto (237 A) ed accessori 1/2	519 M 612CLA	35
Chiavi combinate (6-7-8-9-10-1-12-13-14-15-16-17-18-19-22-24 mm)	519 M 285A1	17
Giraviti per viti ad intaglio ed a croce PHILLIPS	519 M 324H	7
Giraviti per viti TORX	519 M 324STX	8
Pinze per anelli elastici, pinza universale, pinza becchi lunghi, chiavi snodate con bussola esagonale (8-10-13-17 mm), assortimento di inserti con cricchetto	519 M 276C	42

Vuoi solo l'assortimento? Vai a pagina 28



NON TROVI IL TUO ASSORTIMENTO IDEALE?

Configuralo su kitplanner.usag.it



6
CASSETTI

4
MODULI

RISPARMI
€ 260

Rispetto all'acquisto di carrello ed assortimento separati.



6
CASSETTI

4
MODULI

RISPARMI
€ 260

Rispetto all'acquisto di carrello ed assortimento separati.

301
PEZZI

516 STXL6MM
U05160632

RAL 3020

Carrello START con assortimento MANUTENZIONE - 4 cassette

~~€ 3.449,00~~

€ 1.758,00

301
PEZZI

516 STXL6NMM
U05161632

RAL 9005

Carrello START con assortimento MANUTENZIONE - 4 cassette

~~€ 3.449,00~~

€ 1.758,00

ASSORTIMENTO MANUTENZIONE



519 M 612CLA

519 M 613BEA

519 M 613AEA

519 M 285KA

519 M 285A1

519 M 285A2

519 M 294B

519 M 324H

519 M 324STX

519 M 280HG

519 M 280N1

519 M 127C

519 M 150AX

519 M 382F

519 M 990A5MD

DESCRIZIONE

DESCRIZIONE	ART	PZ
Bussole esagonali, cricchetto (237 A), accessori 1/4 ed inserti	519 M 613AEA	46
Bussole esagonali, cricchetto (237 A) ed accessori 3/8	519 M 613BEA	20
Bussole esagonali lunghe e corte, cricchetto (237 A) ed accessori 1/2	519 M 612CLA	35
Chiavi combinate a cricchetto reversibili (8-9-10-11-12-13-14-15-16-17-18-19 mm)	519 M 285 KA	12
Chiavi combinate (6-7-8-9-10-11-12-13-14-15-16-17-18-19-22-24 mm)	519 M 285A1	17
Chiavi combinate (27-29-30-32-34 mm)	519 M 285A2	5
Chiave a rullino rapida e corta, pinza autobloccante e forbice	519 M 294B	4
Giraviti per viti ad intaglio ed a croce PHILLIPS	519 M 324H	7

DESCRIZIONE

DESCRIZIONE	ART	PZ
Giraviti per viti TORX	519 M 324STX	8
Chiavi maschio esagonali con impugnatura (3-4-5-6-7-8-10 mm)	519 M 280HG	7
Cassetta inserti assortita e chiavi maschio esagonali / TORX	519 M 280N1	117
Pinze per anelli elastici interni ed esterni 15÷25 e 19÷60	519 M 127C	6
Pinza universale, pinza regolabile, tronchese, pinza becchi lunghi e pinza grip	519 M 150AX	5
Lime a taglio mezzodolce	519 M 990A5B	5
Martello per meccanici, mazzuola, cacciaspine, scalpello e bulino	519 M 382F	7

200 kg



3

RIPIANI



504 SR
U05040004

RAL
3020

Carrello multiuso

- 3 ripiani da 770x448 mm.
- Ripiani coperti da tappetini in ABS da 2 mm.
- Bordi anticaduta da 37 mm su tutti e 3 i ripiani.
- Maniglia in tubolare d'acciaio diametro 25 mm.
- Fianchi predisposti per gli accessori laterali 516.
- Due ruote pivotanti e due ruote fisse (Ø 100 mm) di cui una con freno.
- Fornito smontato.
- Portata massima: 200 Kg.

504 SN
U05040014

RAL
9005

Carrello multiuso

€ 215,00

€ 149,00



Compatibile con gli accessori della linea 516



Maniglia in tubolare d'acciaio Ø 25 mm.



Ripiani da 770x448 mm con bordo anticaduta da 37 mm.



Ruote antiolio Ø 100 mm.



200 kg



3

RIPIANI

1

CASSETTO

3

MODULI

504 SNA
U05040015

RAL
9005

Carrello multiuso con cassetto

- 3 ripiani da 770x448 mm.
- Ripiani coperti da tappetini in ABS da 2 mm.
- Bordi anticaduta da 37 mm su tutti e 3 i ripiani.
- Maniglia in tubolare d'acciaio diametro 25 mm.
- Fianchi predisposti per gli accessori laterali 516.
- Due ruote pivotanti e due ruote fisse (Ø 100 mm) di cui una con freno.
- Cassetto con guide telescopiche da 20 Kg.
- Doppie chiavi in dotazione.
- Dimensioni interne cassetto: 570x420x60 mm.
- Fornito smontato.
- Portata massima: 200 Kg.

€ 328,00

€ 229,00

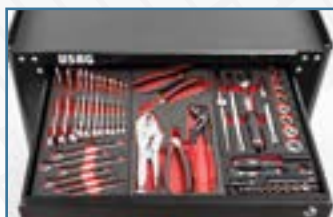

COMPATIBILE CON LA GAMMA MODULI



CARRELLO 519 RACING LA TUA POSTAZIONE DI LAVORO AL TOP.



**DUE RUOTE
CON FRENO**

Piano di lavoro ampio
con doppia maniglia

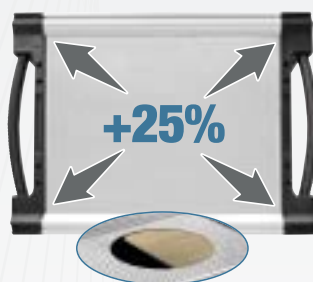

Doppio strato
Sopra: lastra in alluminio da 2 mm.
Sotto: piano in legno da 15 mm.



Paraurti in gomma su
telai e cassetti.



Maniglie ergonomiche
basculanti in alluminio



Risparmia il tuo tempo

Tutti i carrelli a cassetteria USAG sono subito pronti all'uso, perchè forniti con le ruote già montate alla struttura.



900 kg

8
CASSETTI
3
MODULI

79 kg | 814 mm | 1005 mm | 575 mm



900 kg

7
CASSETTI
3
MODULI

77 kg | 814 mm | 1005 mm | 575 mm



900 kg

6
CASSETTI

3
MODULI

75 kg | 814 mm | 1005 mm | 575 mm

519 RS6/3V

U05190506

RAL 3020

Carrello RACING (vuoto)

519 RS6/3NV

U05190516

RAL 9005

Carrello RACING (vuoto)

519 RS8/3V

U05190508

RAL 3020

Carrello RACING (vuoto)

- Dimensioni interne:
 - 6 cassetti 570x420x60 mm.
 - 2 cassetti 570x420x130 mm.

€ 1.366,00 **€ 956,00**

519 RS7/3V

U05190507

RAL 3020

Carrello RACING (vuoto)

- Dimensioni interne:
 - 5 cassetti 570x420x60 mm.
 - 1 cassetto 570x420x130 mm.
 - 1 cassetto 570x420x200 mm.

€ 1.257,00 **€ 880,00**

€ 1.145,00 **€ 802,00**



89 kg | 1004 mm | 1005 mm | 575 mm

519 RS6/4V
U05190546

RAL 3020

Carrello RACING (vuoto)

519 RS6/4NV
U05190566

RAL 9005

Carrello RACING (vuoto)

- Dimensioni interne:
 - 4 cassetti 760x420x60 mm.
 - 1 cassetto 760x420x130 mm.
 - 1 cassetto 760x420x270 mm.

~~€ 1.334,00~~ **€ 934,00**



106 kg | 1194 mm | 1035 mm | 575 mm

519 RS7/5V
U05190556

RAL 3020

Carrello RACING (vuoto)

- Dimensioni interne:
 - 5 cassetti 950x420x60 mm.
 - 1 cassetto 950x420x130 mm.
 - 1 cassetto 950x420x200 mm.

~~€ 1.747,00~~ **€ 1.223,00**



106 kg | 1194 mm | 1035 mm | 575 mm

519 RB07/3V
U05190097

RAL 3020

Carrello RACING con anta laterale (vuoto)

- Dimensioni interne:
 - 5 cassetti 570x420x60 mm.
 - 1 cassetto 570x420x130 mm.
 - 1 cassetto 570x420x200 mm.
- Vano laterale: 380x400x720 mm.

~~€ 1.747,00~~ **€ 1.223,00**



128 kg | 1.212 mm | 1000 mm | 670 mm

519 RBU6/3V
U05190098

RAL 3020

RAL 9005

Banco da lavoro mobile RACING (vuoto)

- Dimensioni interne:
 - 3 cassetti 570x420x60 mm.
 - 2 cassetti 570x420x130 mm.
 - 1 cassetto 570x420x200 mm.
- Vano laterale: 380x524x704 mm.

~~€ 2.186,00~~ **€ 1.530,00**



45 kg | 814 mm | 500 mm | 575 mm

519 RSC4/3V
U05190534

RAL 3020

Cassettiera RACING (vuota)

- Dimensioni interne:
 - 3 cassetti: 570x420x60 mm.
 - 1 cassetto: 570x420x130 mm.

~~€ 835,00~~ **€ 584,00**



51 kg | 1004 mm | 500 mm | 575 mm

519 RSC4/4V
U05190544

RAL 3020

Cassettiera RACING (vuota)

- Dimensioni interne:
 - 3 cassetti: 760x420x60 mm.
 - 1 cassetto: 760x420x130 mm.

~~€ 964,00~~ **€ 674,00**



60 kg | 1194 mm | 500 mm | 575 mm

519 RSC4/5V
U05190554

RAL 3020

Cassettiera RACING (vuota)

- Dimensioni interne:
 - 3 cassetti: 950x420x60 mm.
 - 1 cassetto: 950x420x130 mm.

~~€ 1.085,00~~ **€ 759,00**

NON TROVI IL TUO Configuralo su



6
CASSETTI

3
MODULI

RISPARMI
€ 300

Rispetto all'acquisto di carrello ed assortimento separati.



6
CASSETTI

3
MODULI

RISPARMI
€ 300

Rispetto all'acquisto di carrello ed assortimento separati.

156
PEZZI

519 RS6/3MM
U05190628

RAL 3020



519 RS6/3NMM
U05191628

RAL 9005

Carrello RACING con assortimento MANUTENZIONE - 4 cassetti

€ 2.617,00 **€ 1.310,00**

155
PEZZI

519 RS6/3MA
U05190627

RAL 3020



519 RS6/3NMA
U05191627

RAL 9005

Carrello RACING con assortimento AUTORIPARAZIONE - 3 cassetti

€ 2.601,00 **€ 1.310,00**

ASSORTIMENTO MANUTENZIONE



519 M 613AEA 519 M 613CEA 519 M 285A1



519 M 127C 519 M 150AX 519 MSK6



519 M 324H 519 M 324STX 519 MSK6+ 692 J32



519 M 990A5B 519 M 382 519 MSK6



519 M 285A1 519 M 324H 519 M 324STX



519 M 613AEA 519 M 612CLA



519 M 276C



CHIAVI A T SNODATE
8-10-13-17 mm

DESCRIZIONE

DESCRIZIONE	ART	PZ
Bussole esagonali, cricchetto (237 A), accessori 1/4 ed inserti	519 M 613AEA	46
Bussole esagonali, cricchetto (237 A) ed accessori 1/2	519 M 613CEA	23
Chiavi combinate (6-7-8-9-10-11-12-13-14-15-16-17-18-19-22-24 mm)	519 M 285A1	17
Pinze per anelli elastici interni ed esterni 15÷25 e 19÷60	519 M 127C	6
Pinza universale, pinza regolabile, tronchese, pinza becchi lunghi e pinza grip	519 M 150AX	5
Giraviti per viti ad intaglio ed a croce PHILLIPS	519 M 324H	7
Giraviti per viti TORX	519 M 324STX	8
Lime a taglio mezzodolce	519 M 990A5B	5
Martello per meccanici, mazzuola, cacciaspine, scalpello e bulino	519 M 382F	7
Assortimento di inserti con cricchetto reversibile	692 J32	32

DESCRIZIONE

DESCRIZIONE	ART	PZ
Bussole esagonali, cricchetto (237 A), accessori 1/4 ed inserti	519 M 613AEA	46
Bussole esagonali lunghe e corte, cricchetto (237 A) ed accessori 1/2	519 M 612CLA	35
Chiavi combinate (6-7-8-9-10-11-12-13-14-15-16-17-18-19-22-24 mm)	519 M 285A1	17
Giraviti per viti ad intaglio ed a croce PHILLIPS	519 M 324H	7
Giraviti per viti TORX	519 M 324STX	8
Pinze per anelli elastici, pinza universale, pinza becchi lunghi, chiavi snodate con bussola esagonale (8-10-13-17 mm), assortimento di inserti con cricchetto	519 M 276C	42

ASSORTIMENTO IDEALE?

kitplanner.usag.it



6
CASSETTI

4
MODULI

RISPARMI
€ 400

Rispetto all'acquisto di carrello ed assortimento separati.



6
CASSETTI

4
MODULI

RISPARMI
€ 400

Rispetto all'acquisto di carrello ed assortimento separati.

301
PEZZI

519 RS6/4MM
U05190632

RAL 3020

Carrello RACING con assortimento MANUTENZIONE - 4 cassette

~~€ 3.918,00~~

€ 1.953,00



301
PEZZI

519 RS6/4NMM
U05191632

RAL 9005

Carrello RACING con assortimento MANUTENZIONE - 4 cassette

~~€ 3.918,00~~

€ 1.953,00



ASSORTIMENTO MANUTENZIONE



DESCRIZIONE	ART	PZ
Bussole esagonali, cricchetto (237 A), accessori 1/4 ed inserti	519 M 613AEA	46
Bussole esagonali, cricchetto (237 A) ed accessori 3/8	519 M 613BEA	20
Bussole esagonali lunghe e corte, cricchetto (237 A) ed accessori 1/2	519 M 612CLA	35
Chiavi combinate a cricchetto reversibili (8-9-10-12-13-14-15-16-17-18-19 mm)	519 M 285 KA	12
Chiavi combinate (6-7-8-9-10-12-13-14-15-16-17-18-19-22-24 mm)	519 M 285A1	17
Chiavi combinate (27-29-30-32-34 mm)	519 M 285A2	5
Chiave a rullino rapida e corta, pinza autobloccante e forbice	519 M 294B	4
Giraviti per viti ad intaglio ed a croce PHILLIPS	519 M 324H	7

DESCRIZIONE	ART	PZ
Giraviti per viti TORX	519 M 324STX	8
Chiavi maschio esagonali con impugnatura (3-4-5-6-7-8-10 mm)	519 M 280HG	7
Cassetta inserti assortita e chiavi maschio esagonali / TORX	519 M 280N1	117
Pinze per anelli elastici interni ed esterni 15÷25 e 19÷60	519 M 127C	6
Pinza universale, pinza regolabile, tronchese, pinza becchi lunghi e pinza grip	519 M 150AX	5
Lime a taglio mezzodolce	519 M 990A5B	5
Martello per meccanici, mazzuola, cacciaspine, scalpello e bulino	519 M 382F	7

Vuoi solo l'assortimento? Vai a pagina 28

MODULI IN SPUGNA BICOLORE



519 M 613AEA 519 M 613CEA 519 M 285A1



519 M 127C 519 M 150AX 519 MSK6



519 M 324H 519 M 324STX 519 MSK6+692 J32



519 M 990A5B 519 M 382 519 MSK6



519 M 285A1 519 M 324H 519 M 324STX



519 M 613AEA 519 M 612CLA



519 M 276C



CHIAVI A T SNODATE
8-10-13-17 mm

495 MB
U04950628

156
PEZZI



Assortimento MANUTENZIONE - 4 cassette

DESCRIZIONE	ART	PZ
Bussole esagonali, cricchetto (237 A), accessori 1/4 ed inserti	519 M 613AEA	46
Bussole esagonali, cricchetto (237 A) ed accessori 1/2	519 M 613CEA	23
Chiavi combinate (6-7-8-9-10-11-12-13-14-15-16-17-18-19-22-24 mm)	519 M 285A1	17
Pinze per anelli elastici interni ed esterni 15÷25 e 19÷60	519 M 127C	6
Pinza universale, pinza regolabile, tronchese, pinza becchi lunghi e pinza grip	519 M 150AX	5
Giraviti per viti ad intaglio ed a croce PHILLIPS	519 M 324H	7
Giraviti per viti TORX	519 M 324STX	8
Lime a taglio mezzodolce	519 M 990A5B	5
Martello per meccanici, mazzuola, cacciaspine, scalpello e bulino	519 M 382F	7
Assortimento di inserti con cricchetto reversibile	692 J32	32

~~€ 1.472,00~~

€ 809,00

495 MAA
U04950627

155
PEZZI



Assortimento AUTORIPARAZIONE - 3 cassette

DESCRIZIONE	ART	PZ
Bussole esagonali, cricchetto (237 A), accessori 1/4 ed inserti	519 M 613AEA	46
Bussole esagonali lunghe e corte, cricchetto (237 A) ed accessori 1/2	519 M 612CLA	35
Chiavi combinate (6-7-8-9-10-11-12-13-14-15-16-17-18-19-22-24 mm)	519 M 285A1	17
Giraviti per viti ad intaglio ed a croce PHILLIPS	519 M 324H	7
Giraviti per viti TORX	519 M 324STX	8
Pinze per anelli elastici, pinza universale, pinza becchi lunghi, chiavi snodate con bussola esagonale (8-10-13-17 mm), assortimento di inserti con cricchetto	519 M 276C	42

~~€ 1.456,00~~

€ 809,00



519 M 612CLA 519 M 613BEA 519 M 613AEA



519 M 285KA 519 M 285A1 519 M 285A2 519 M 294B

301
PEZZI



495 MC
U04950632

Assortimento MANUTENZIONE
4 cassette

~~€ 2.584,00~~

€ 1.419,00

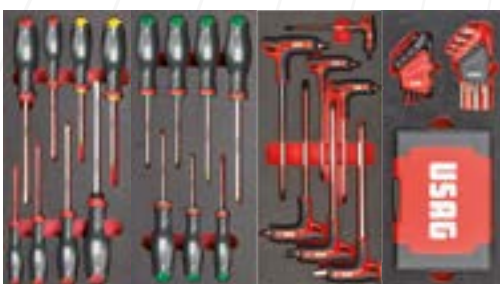

519 M 324H 519 M 324STX 519 M 280HG 519 M 280N1



519 M 127C 519 M 150AX 519 M 382F 519 M 990A5MD

MODULI IN PLASTICA



519/613AEA 519/613CEA 519 SK692V



519/285A1 519/150AX 519 SK692V



519/324H 519/324TX 519 SK692V + 692 J32



519 SK692V 519/990A1 519/382F



519/613AEA 519/613CEA 519 SK692V + 692 J32



519/324H 519/285A1 519/150AX

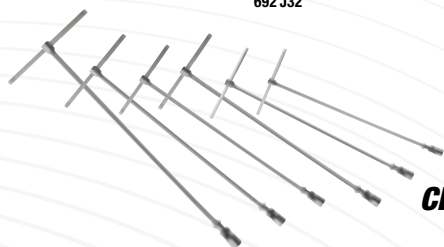

CHIAVI A T SNODATE
7-8-10-12-13-17 mm

DESCRIZIONE	ART	PZ
Bussole esagonali, cricchetto (237 A), accessori 1/4 ed inserti	519 M 613AEA	46
Bussole esagonali, cricchetto (237 A) ed accessori 3/8	519 M 613BEA	20
Bussole esagonali lunghe e corte, cricchetto (237 A) ed accessori 1/2	519 M 612CLA	35
Chiavi combinate a cricchetto reversibili (8-9-10-1-12-13-14-15-16-17-18-19 mm)	519 M 285 KA	12
Chiavi combinate (6-7-8-9-10-1-12-13-14-15-16-17-18-19-22-24 mm)	519 M 285A1	17
Chiavi combinate (27-29-30-32-34 mm)	519 M 285A2	5
Chiave a rullino rapida e corta, pinza autobloccante e forbice	519 M 294B	4
Giraviti per viti ad intaglio ed a croce PHILLIPS	519 M 324H	7
Giraviti per viti TORX	519 M 324STX	8
Chiavi maschio esagonali con impugnatura (3-4-5-6-7-8-10 mm)	519 M 280HG	7
Cassetta inserti assortita e chiavi maschio esagonali / TORX	519 M 280N1	117
Pinze per anelli elastici interni ed esterni 15÷25 e 19÷60	519 M 127C	6
Pinza universale, pinza regolabile, tronchese, pinza becchi lunghi e pinza grip	519 M 150AX	5
Lime a taglio mezzodolce	519 M 990A5B	5
Martello per meccanici, mazzuola, cacciaspina, scalpello e bulino	519 M 382F	7

495 PM
U04950630

157
PEZZI



Assortimento MANUTENZIONE - 4 cassette

DESCRIZIONE	ART	PZ
Bussole esagonali, cricchetto (237 A), accessori 1/4 ed inserti	519/613AEA	42
Bussole esagonali, cricchetto (237 A) ed accessori 1/2	519/613CEA	22
Chiavi combinate (6÷24 mm) + chiavi maschio esagonali (1,5÷10 mm)	519/285A1	25
Pinza universale, pinza regolabile, tronchese, pinza becchi lunghi e pinza grip	519/150AX	5
Giraviti per viti ad intaglio ed a croce PHILLIPS	519/324H	10
Giraviti per viti TORX	519/324TX	9
Lime a taglio mezzodolce	519/990A1	4
Martello per meccanici, mazzuola, cacciaspina, scalpello e bulino	519/382F	8
Assortimento di inserti con cricchetto reversibile	692 J32	32

€ 1.234,00

€ 629,00

495 PA
U04950629

142
PEZZI



Assortimento AUTORIPARAZIONE - 2 cassette

DESCRIZIONE	ART	PZ
Bussole esagonali, cricchetto (237 A), accessori 1/4 ed inserti	519/613AEA	42
Bussole esagonali, cricchetto (237 A) ed accessori 1/2	519/613CEA	22
Giraviti per viti ad intaglio ed a croce PHILLIPS	519/324H	10
Chiavi combinate (6÷24 mm) + chiavi maschio esagonali (1,5÷10 mm)	519/285A1	25
Pinza universale, pinza regolabile, tronchese, pinza becchi lunghi e pinza grip	519/150AX	5
Chiavi a T snodate con bocca esagonale (7-8-10-12-13-17 mm)	276 CE	6
Assortimento di inserti con cricchetto reversibile	692 J32	32

€ 1.148,00

€ 629,00



NON TROVI IL TUO ASSORTIMENTO IDEALE?

Configuralo su kitplanner.usag.it

Moduli in plastica



519/127N
U05190716 **4 PEZZI**
127 N 19÷60 · 127 PN 19÷60 ·
128 N 19÷60 · 128 PN 19÷60.
€ 111,00 **€ 77,50**



519/150AX
U05190850 **5 PEZZI**
133 AX 160 · 134 250 · 150 AX 180 ·
180 C 250 · 188 AX 160.
€ 163,00 **€ 114,00**



519/280HG
U05191860 **7 PEZZI**
280 HG 3-4-5-6-7-8-10.
€ 109,00 **€ 76,50**



519/280HGTS
U05191861 **7 PEZZI**
280 HGTS 3-4-5-6-7-8-10.
€ 119,00 **€ 83,50**



519/285A1
U05190785 **25 PEZZI**
285 6-7-8-9-10-11-12-13-14-15-16-17-
18-19-22-24 280 S9 1,5÷10.
€ 184,00 **€ 129,00**



519/285B2
U05190823 **4 PEZZI**
285 27-29-30-32.
€ 100,00 **€ 70,00**



519/285KA1
U05190788 **12 PEZZI**
285 KA 8-9-10-11-12-13-14-15-
16-17-18-19.
€ 236,00 **€ 165,00**



519/294
U05190732 **9 PEZZI**
204 250 · 294 A 250 · 367 2x110-3x130-
4x145-5x165-6x180-8x200 · 981 A3.
€ 120,00 **€ 84,00**



519/322H
U05190772 **10 PEZZI**
322 0,5x3x75-0,8x4x100-1x5,5x125-
1,2x6,5x150-1,6x8x175 · 322 PH 0x75-1x100-
2x125 · 322 N 0,8x4x30 · 322 NPH 2x30.
€ 62,00 **€ 43,40**



519/322STX
U05190831 **6 PEZZI**
322 STX T10-T15-T20-T25-T30-T40.
€ 55,50 **€ 38,80**



519/324H
U05190763 **10 PEZZI**
324 0,5x3x75-0,8x4x100-1x5,5x125-
1,2x6,5x150-1,2x8x200 · 324 PH 0x75-1x75-
2x100 · 324 N 0,8x4x35 · 324 NPH 2x35.
€ 80,50 **€ 56,50**



519/324TX
U05190764 **9 PEZZI**
324 TX T6x50-T7x50-T8x50-T9x75 · 324 STX
T10x75-T15x75-T20x100-T25x100-T30x125.
€ 106,00 **€ 74,00**



519/366
U05190740 **7 PEZZI**
351 200 · 362 125-150 · 364 125 ·
366 3x125 · 4x150 · 368 4x125.
€ 80,00 **€ 56,00**



519/382F
U05190742 **8 PEZZI**
362 150 · 367 2x100-3x130-4x145-
5x165 · 368 4x125 · 376 35 · 382F 500.
€ 99,50 **€ 69,50**



519/613AEA **42 PEZZI**
U05190784 237 A
235 1/4" EN 4-4,5-5-5,5-6-7-8-9-10-11-12-13-
14 · 236 1/4" 50-150 · 237 A 1/4" · 240 1/4" ·
241 1/4" · 243 1/4" · 692 S11 · 692 STX/S11 ·
684 1/4"-1/4".
€ 209,00 **€ 146,00**



519/613BEA **21 PEZZI**
U05190747 237 A
235 3/8" E 6-7-8-9-10-11-12-13-14-15-
16-17-18-19-21-22 · 236 3/8" 125-250 ·
237 A 3/8" · 240 3/8" N · 241 3/8".
€ 213,00 **€ 149,00**



519/613CEA **22 PEZZI**
U05190750 237 A
235 1/2" EN 10-11-12-13-14-15-16-
17-18-19-20-21-22-24-27-30-32 · 236
1/2" 125-250 · 237 A 1/2" · 240 1/2" N ·
241 1/2".
€ 257,00 **€ 180,00**



519/990A1 **4 PEZZI**
U05190825
990 M PA/200 · 990 M PB/200
990 M PC/200 · 990 M PE/200.
€ 57,50 **€ 40,30**



8 PEZZI XL
519/280T
U05190727
280 T 2-2,5-3-4-5-6-8-10.
€ 155,00 **€ 109,00**



Crea il tuo assortimento ideale su kitplanner.usag.it!

Scopri tutta la gamma di moduli in plastica su usag.it o inquadra il QR code



8 PEZZI XXL
519/276
U05190725
276 CE 7-8-10-11-13-14-17-19.
€ 364,00 **€ 255,00**

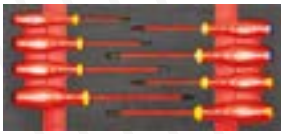

519 M 091A
U05191016 **8 PEZZI**
091 0,5x3x75-0,8x4x100-1x5,5x125
1,2x6,5x150 · 091 PH 1x100-2x125
· 091 PZ 1x100-2x125.
€ 94,50 **€ 66,00**



519 M 127N
U05190937 **4 PEZZI**
127 N 19÷60 · 127 PN 19÷60 ·
128 N 19÷60 · 128 PN 19÷60.
€ 117,00 **€ 82,00**



519 M 150AX
U05190965 **5 PEZZI**
133 AX 160 · 134 250 · 150 AX 180 ·
180 C 250 · 188 AX 160.
€ 169,00 **€ 118,00**

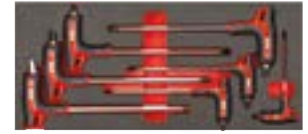

519 M 280HG
U05191945 **7 PEZZI**
280 HG 3-4-5-6-7-8-10.
€ 115,00 **€ 80,50**

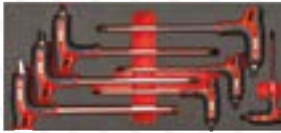

519 M 280HGTS
U05191946 **7 PEZZI**
280 HGTS 3-4-5-6-7-8-10.
€ 125,00 **€ 87,50**



519 M 280N1
U05191013 **117 PEZZI**
280 S9 1,5-2-2,5-3-4-5-6-8-10 · 280 TX/
S8C T10-T15-T20-T25-T27-T30-T40-T45
· 692 J100.
€ 133,00 **€ 93,00**



519 M 280TK
U05190935 **6 PEZZI**
280 TK 2,5-3-4-5-6-8.
€ 125,00 **€ 90,00**



519 M 285A1
U05190921 **17 PEZZI**
285 6-7-8-9-10-11-12-13-14-15-16-
17-18-19-21-22-24.
€ 177,00 **€ 124,00**



519 M 285A2
U05190943 **5 PEZZI**
285 27-29-30-32-34.
€ 144,00 **€ 101,00**



519 M 285KA
U05190944 **12 PEZZI**
285 KA 8-9-10-11-12-13-14-15-
16-17-18-19.
€ 241,00 **€ 169,00**



519 M 285KB
U05191060 **12 PEZZI**
285 KB 8-9-10-11-12-13-14-15-
16-17-18-19.
€ 184,00 **€ 129,00**



519 M 294B
U05191015 **4 PEZZI**
135 A 250 · 207 E · 294 AC · 294 AD 250.
€ 176,00 **€ 123,00**



519 M 324H
U05190910 **8 PEZZI**
324 0,5x3x75-0,8x4x100-1x5,5x125-
1,2x6,5x150 · 324 PH 1x100-2x125
324 D 0,6x3,5x100 324 E 1,6x8x175.
€ 76,50 **€ 53,50**



519 M 324STX
U05190911 **7 PEZZI**
324 STX T10x75-T15x75-T20x100-
T25x100-T27x100-T30x125-T40x150.
€ 107,00 **€ 75,00**



519 M 382F
U05190926 **7 PEZZI**
362 175 · 367 2x100-3x130-6x180
368 3x100 · 376 28 · 382F 500.
€ 122,00 **€ 85,50**



519 M 613AEA **46 PEZZI**
U05190940 237 A
235 1/4" EN 5,5-6-7-8-9-10-11-12-13-14 · 236
1/4" 50-100 · 237 A 1/4" · 240 1/4" · 241 1/4" ·
243 1/4" · 280 LTS/S9 · 684 1/4" · 1/4" · 660 0,6-
1-1,6 · 660 E 3-4-5-6-8 · 660 PH 1-2-3 · 660 PZ
1-2-3 · 660 STX T15-T20-T25-T27-T30-T40.
€ 248,00 **€ 174,00**



519 M 613BEA **20 PEZZI**
U05190928 237 A
235 3/8" E 7-8-9-10-11-12-13-14-15-16-
17-18-19-21-22 · 236 3/8" 125-250 ·
237 A 3/8" · 240 3/8" N · 241 3/8".
€ 213,00 **€ 149,00**



519 M 613CEA **23 PEZZI**
U05190942 237 A
235 1/2" EN 8-10-11-12-13-14-15-16-
17-18-19-21-22-23-24-27-30-32 · 236
1/2" 125-250 · 237 A 1/2" · 240 1/2" N
· 241 1/2".
€ 269,00 **€ 188,00**



519 M 990A5MD
U05191011 **5 PEZZI**
990 M PA/200 · 990 M PB/200 · 990 M
PG/200 · 990 M PD/200 · 990 M PE/200.
€ 76,00 **€ 53,00**



**Scopri tutta la gamma di
moduli in spugna su usag.it
o inquadra il QR code**



8 PEZZI XL
519 M 280T
U05191059
280 T 2-2,5-3-4-5-6-8-10.
€ 164,00 **€ 115,00**

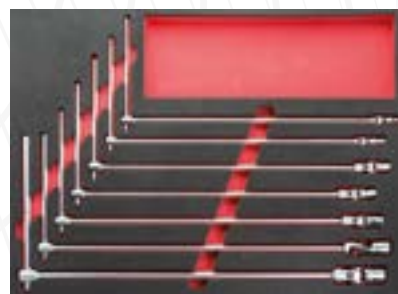

7 PEZZI XXL
519 M 276
U05190936
276 CE 7-8-10-11-13-17-19.
€ 340,00 **€ 248,00**

13 kg | 460 mm | 158 mm | 385 mm



002 JMA

U00020011

Valigia con assortimento per manutenzione

- Valigia con struttura in profilato di Alluminio.
- Doppia cerniera di chiusura in metallo con serratura.
- 3 pannelli portautensili interni con elastici di tenuta.
- Base con interno in spugna bicolore sagomata.

€ 728,00

€ 419,00



PINZE SERIE AX, GIRAVITI 324 E CHIAVE A RULLINO 294 AD!



181
PEZZI



002 JTMA

U00020015

Valigia trolley con assortimento per manutenzione

- Valigia con struttura in profilato di Alluminio.
- Doppia cerniera di chiusura in metallo con serratura.
- 3 pannelli portautensili interni con elastici di tenuta.
- Base con interno in spugna bicolore sagomata.

€ 728,00

€ 439,00



**RUOTE INTEGRATE
NELLA STRUTTURA**

14 kg | 485 mm | 200 mm | 377 mm





002 UDM

U00021706W

Valigia con assortimento per manutenzione

- Valigia con struttura in profilato di Alluminio.
- Doppia cerniera di chiusura in metallo con serratura.
- 3 pannelli portautensili interni con elastici di tenuta.
- Base con interno in mousse bicolore sagomata.

10 kg | 460 mm | 158 mm | 385 mm

€ 929,00

€ 459,00

74
UTENSILI

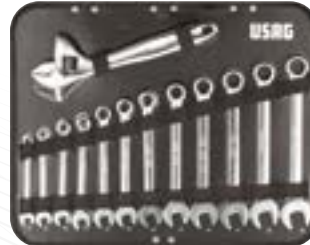

INSIEME UNICI



002 UDE

U00022706W

Valigia con assortimento per elettricisti

€ 760,00

€ 459,00

74
UTENSILI

10 kg | 460 mm | 158 mm | 385 mm

1000 V

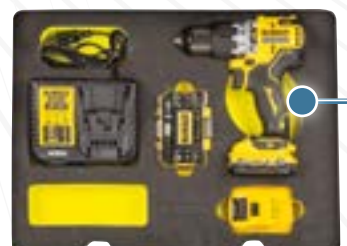

Modello con percussione



Batterie da 3.0 AH

DCD706

Trapano avvitatore a percussione

- Coppia 57Nm.
- 0-425/1500 giri/minuto.
- Mandrino in metallo autoserrante 1-10mm.
- Caricabatterie rapido.

12V XR

**2 BATTERIE 12V
3.0 AH INCLUSE**





420 mm

MAX
11 kg

CAPACITÀ
34 L



Tutta l'attrezzatura a portata di mano

007/1V
U00070001

2,5 kg | mm | 420
340
240

Borsa portautensili (vuota)

- Nylon ad altissima resistenza.
- Base rigida e resistente all'acqua.
- Pratici e comodi vani interni portautensili.
- Due tasche frontali portaminuteria.
- Pratico maniglione in alluminio.
- Ganci interni porta flessometro ed elastici portautensili.
- Mantella di chiusura tramite velcro.

~~€ 80,00~~

€ 56,00



490 mm

MAX
15 kg

CAPACITÀ
47 L



Tasca frontale porta seghetto

007 V
U00070002

4 kg | mm | 490
350
220

Borsa portautensili (vuota)

- Nylon ad altissima resistenza.
- Base rigida resistente all'acqua.
- Vani interni portautensili e tasca frontale porta seghetto.
- Maniglione in alluminio con impugnatura rivestita.
- Cinghia di trasporto a tracolla.
- Mantella di chiusura con velcro.

~~€ 104,00~~

€ 73,00



550 mm

MAX
18 kg

CAPACITÀ
33 L



Maniglia telescopica

007 TXV
U00070065

5,4 kg | mm | 550
440
360

Borsa trolley portautensili (vuota)

- Tessuto ad altissima resistenza
- Maniglia telescopica.
- Ruote con diametro 90 mm.
- 6 tasche esterne e 1 tasca frontale porta seghetto.
- Vani interni portautesili.
- Maniglione in alluminio con impugnatura rivestita.
- Mantella di chiusura con velcro.

~~€ 165,00~~

€ 99,00



Tasca frontale porta seghetto



Ruote con diametro 90 mm



MAX
10 kg

CAPACITÀ
15 L

007 MCV
U00070008

1 kg | mm | → 360
↓ 280
↙ 190

Borsa portautensili (vuota)

- Tessuto ad altissima resistenza.
- Base rigida resistente all'acqua.
- Vani interni portautensili.
- 3 tasche frontali con mantella di protezione.
- 3 tasche posteriori.
- Maniglie con rivestimento in PVC.
- Cinghia di trasporto a tracolla.

€ 57,00

€ 40,00



MAX
9 kg

CAPACITÀ
8 L

007 FLV
U00070007

470 g | mm | → 310
↓ 220
↙ 140

Borsa portautensili (vuota)

- Tessuto ad altissima resistenza.
- Tasca frontale con chiusura a cerniera.
- Tasca posteriore con chiusura a velcro.
- Base rigida rinforzata.
- Vani interni portautensili.
- Maniglie con rivestimento in PVC.

€ 29,00

€ 20,00



MAX
25 kg

CAPACITÀ
9 L

007 PLV
U00070034

1,7 kg | mm | → 450
↓ 170
↙ 180

Borsa termoidraulico (vuota)

- Tessuto ad altissima resistenza.
- Base rigida rivettata per aumentare la resistenza al carico.
- Tasca portadocumenti interna.
- Può contenere un giratubi fino a 1 1/2".
- Gancio esterno ferma flessometro.
- Tracolla amovibile per un comfort extra nel trasporto.
- Due maniglie superiori per una migliore presa.
- Chiusura tramite velcro e fibbie a scatto con sgancio rapido.

€ 60,50

€ 42,00





MAX
15 kg

CAPACITÀ
8 L



L'apertura frontale consente un rapido accesso al contenuto.



007 RV
U00070033

1,8 kg | mm → 460
↓ 160
↗ 350

Borsa per utensili e PC (vuota)

- Tessuto ad altissima resistenza.
- Base rigida rinforzata.
- Può contenere Notebook di dimensioni L:340 mm - H:240 mm.
- 14 tasche, 2 cinghie portautensili e 1 gancio ferma flessometro.
- Tracolla amovibile per un comfort extra nel trasporto.
- Chiusura tramite fibbie a scatto con sgancio rapido.

~~€ 68,50~~

€ 48,00

MAX
12 kg

CAPACITÀ
30 L



Tasca porta Notebook o documenti



007 SV
U00070004

3,1 kg | mm → 355
↓ 225
↗ 460

Zaino portautensili (vuoto)

- Nylon ad altissima resistenza.
- Cinturino pettorale regolabile.
- Cinghie in vita imbottite.
- Base rigida resistente all'acqua.
- Vano interno portautensili.
- Portadocumenti interno.
- La tasca posteriore può contenere Notebook di dimensioni: L 340 mm - H 240 mm.

~~€ 97,50~~

€ 69,00



Tasca porta Notebook o documenti



007 TV
U00070006

3,5 kg | mm → 350
↓ 500
↗ 200

Trolley portautensili (vuoto)

- Dimensioni bagaglio a mano (cabin size).
- Tessuto ad altissima resistenza.
- Pratici e comodi vani interni portautensili.
- Tasca frontale portadocumenti.
- Tasche laterali con cinghie per il trasporto di oggetti lunghi.
- Asta telescopica in alluminio.
- Ruote integrate nella struttura.
- Bretelle posteriori per il trasporto a spalla.
- La tasca posteriore può contenere Notebook di dimensioni L:340 mm - H:240 mm.

~~€ 121,00~~

€ 85,00

MAX
14 kg

CAPACITÀ
30 L



MAX
20 kg

4,7 kg | mm | 465
352
215



001 RV
U00010004

Valigia porta utensili in polipropilene ad alto spessore (vuota)

- Due pannelli interni amovibili con elastici portautensili.
- Vano inferiore con divisori amovibili e regolabili.
- Doppia serratura con chiave.

~~€ 293,00~~

€ 205,00

MAX
20 kg

6 kg | mm | 465
352
255



001 TRV
U00010005

Valigia trolley porta utensili in polipropilene ad alto spessore (vuota)

- Maniglia telescopica in alluminio.
- Ruote con cuscinetto a sfera integrato.

~~€ 431,00~~

€ 302,00



5
SCOMPARTI

6,6 kg | mm | 560
320
220



646/5LV
U06460301

Cassetta estensibile LUNGA (vuota)

- Predisposizione per lucchetto.
- Struttura in lamiera d'acciaio con verniciatura anaforetica.

~~€ 82,50~~

€ 58,00

8
VASCHETTE

1,5 kg | mm | 422
106
335



640 A
U06400001

Organizer (vuoto)

- Coperchio trasparente: visibilità istantanea del contenuto.
- 8 vaschette interne amovibili di cui 1 suddivisibile tramite 2 divisori in dotazione.

~~€ 32,00~~

€ 22,40

641 T

Cassetta portautensili (vuota)

- In materiale plastico ad alta resistenza.
- 2 scomparti portaminuteria sul coperchio.
- Possibilità di chiusura con lucchetto (non fornito).
- Vassoio interno amovibile.

	CODICE	L (mm)	P (mm)	H (mm)	kg		
A	U06410004	16"	394	220	1,2 kg	€ 23,60	€ 16,50
B	U06410005	19"	486	266	2,1 kg	€ 35,40	€ 24,80
C	U06410006	24"	595	281	2,8 kg	€ 47,20	€ 33,00





GIRAVITE ELETTRICO 324 XP

LA VELOCITÀ DELLA BATTERIA, LA SENSIBILITÀ DEL TUO POLSO.



ILLUMINAZIONE
a 5 LED frontali con
autospegnimento a 10 secondi.



SISTEMA DI BLOCCAGGIO
automatico del mandrino per
applicare la coppia a mano.



**PORTAINSERTI
MAGNETICO**
con ghiera a
sgancio rapido.



IMPUGNATURA
ergonomica in gomma
resistente ad olii e
prodotti chimici.

IEC 60529

CE
EN 60529

CARATTERISTICHE TECNICHE

Vibrazioni (mm/s ²)	1,4
Potenza sonora dB(A)	54
Dimensioni (mm)	170x39
Peso (gr)	245



LITHIUM
Batteria 3.6V al litio
da 2 Ah.

<15%
15÷74%
75÷100%



RICARICABILE
LED di indicazione
dello stato di carica.
Carica completa in 70
minuti (IN: 5V = 3A).

AVVITA LUI. STRINGI TU.



300
Giri/min
0,9 Nm

LA SUA VELOCITÀ

Avvita e svita velocemente con i
300 giri/min del motore elettrico.

LA TUA SENSIBILITÀ

Finisci il serraggio con la sensibilità
di un giravite manuale.

10 Nm



Nylon ad alta
resistenza



Elastici portainseriti



324 XP/B16
U03240801

16
PEZZI

Giravite elettrico in astuccio con inserti

- Astuccio in nylon ad alta resistenza.
- Elastici portainseriti.
- Tasca interna per il cavo USB-C.
- Gancio per cintura.

€ 242,00

€ 99,00



GIRAVITI 324 IL TOP DEL MERCATO.



IMPUGNATURA TRIMATERIALE

- 1 Esterno in poliuretano resistente ad oli ed agenti chimici.
- 2 Corpo in poliammide resistente agli sforzi.
- 3 Interno in poliammide ad alta densità per un perfetto accoppiamento alla lama.

LAMA RINFORZATA

Acciaio al cromo silicio vanadio per la massima resistenza meccanica.

PUNTA AL TOP

Finitura zincata. Geometria perfetta. Trattamento anti corrosione.

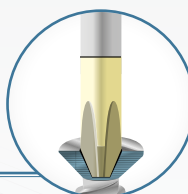

RIVESTIMENTO SOFT GRIP

Miglior comfort durante l'uso. Maggior trasmissione della coppia.

GEOMETRIA ANTI-ROTOLOAMENTO

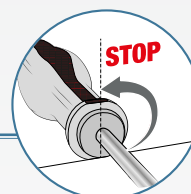

YouTube



324 SH5 U03240645

Serie di 5 giraviti per viti con intaglio e impronta a croce PHILLIPS®

- 324 D/0,8x4x100-1x5,5x125.
- 324 PH/0x75-1x75-2x100.

5
PEZZI



€ 34,80

€ 24,40



324 SH8 U03240650

Serie di 8 giraviti per viti con intaglio e impronta a croce PHILLIPS®

- 324 D/0,4x2,5x50.
- 324/0,5x3x75-0,8x4x100-1x5,5x125-1,2x6,5x150.
- 324 PH/0x75-1x75-2x100.

8
PEZZI



€ 52,00

€ 33,00



324 SH12 U03240651

Serie di 12 giraviti per viti con intaglio, impronta a croce PHILLIPS® e impronta a croce POZIDRIV® - SUPADRIV®

- 324 D/0,4x2,5x50.
- 324/0,5x3x75-0,8x4x100-1x5,5x125-1,2x6,5x150.
- 324 N/1x5,5x35.
- 324 PH/0x75-1x75-2x100.
- 324 NPH/2x35.
- 324 PZ/1x75-2x100.

12
PEZZI



€ 88,00

€ 58,00



324 STX/S7 U03240662

Serie di 7 giraviti con impronta TORX® Tamper Resistant

- 324 STX T10x75-T15x75-T20x100-T25x100-T27x100-T30x125-T40x150.

7
PEZZI



€ 95,00

€ 61,00

GIRAVITI 322 QUALITÀ E CONVENIENZA.



7
PEZZI



322 SH7

U03220254

Serie di 7 giraviti per viti con intaglio e impronta a croce PHILLIPS®

- 322//0,4x2x50-0,5x3x75-0,8x4x100-1,5,5x100-1,2x6,5x150.
- 322 PH/1x100-2x125.

€ 36,40

€ 25,50



10
PEZZI



322 SH10

U03220255

Serie di 10 giraviti per viti con intaglio, impronta a croce PHILLIPS® e impronta a croce POZIDRIV®

- 322//0,4x2x50-0,5x3x75-0,8x4x100-1x5,5x100-1,2x6,5x150.
- 322 PH/0x75-1x100-2x125.
- 322 PZ/1x100-2x125

€ 54,00

€ 37,80

GIRAVITI 091

ISOLATI 1000 V - EN 60900.

USAG SLIM

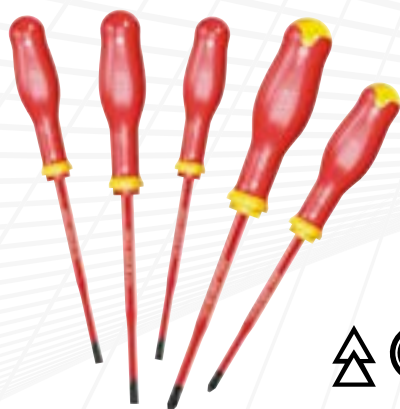

5
PEZZI

091 D/SH5

U00910119

Serie di 5 giraviti SLIM per viti con intaglio e per viti con impronta a croce PHILLIPS®

- 091 D/0,6x3,5x100-0,8x4x100-1x5,5x125.
- 091 DPH/1x100-2x125.

€ 58,00

€ 40,60



5
PEZZI

091 SH5

U00910100

Serie di 5 giraviti per viti con intaglio e per viti con impronta a croce PHILLIPS®

- 091//0,5x3x75-0,8x4x100-1x5,5x125.
- 091 PH/1x100-2x125.

€ 47,60

€ 33,30



8
PEZZI

091 SH8

U00910106

Serie di 8 giraviti per viti con intaglio, per viti con impronta a croce PHILLIPS® e impronta a croce POZIDRIV® - SUPADRIV®

- 091//0,5x3x75-0,8x4x100-1x5,5x125-1,2x6,5x150.
- 091 PH/1x100-2x125.
- 091 PZ/1x100-2x125.

€ 82,00

€ 57,00



YouTube

8
PEZZI

1/4

CRICCHETTO INTEGRATO



CRICCHETTO INTEGRATO



Fornito senza
inserti USAG 660

10
PEZZI

1/4

333 K/SH8

U03330142



Assortimento COMBIDRIVE con inserti

- Fornito con una selezione di 6 inserti da 1/4".

DESCRIZIONE	ARTICOLO/MISURA	PZ
Impugnatura Combidrive	333 K	1
Lama portainseri magnetica	333 1/4 MG	1
Inserti ad intaglio	660/0,6x4,5-1x5,5	2
Inserti a croce PH	660 PH 1-2	2
Inserti esagonali	660 E 3-4	2

€ 61,00

€ 41,30

333 K/SB10

U03330143



Assortimento COMBIDRIVE in astuccio di nylon

- Fornito con una selezione di lame.
- Include un astuccio da cintura in nylon.

DESCRIZIONE	ARTICOLO/MISURA	PZ
Impugnatura Combidrive	333 K	1
Lama portainseri magnetica	333 1/4 MG	1
Lame reversibili ad intaglio	333 I 0,6x3,5-0,8x4/1x5,5-1,2x6,5	2
Lame reversibili a croce PH	333 PH 0-1/2-3	2
Lame reversibili TORX®	333 TX T8-T9	4
	333 STX T10-T15/T20-T25/T30-T40	4

€ 108,00

€ 73,00

280 TQ

U02800800

Chiave a T portainseri

- Doppio portainseri esagonale magnetico da 1/4".
- Capacità massima del portainseri: inserto per viti esagonali incassate misura 6 mm oppure viti Torx misura T40.
- Estremità con quadro portabussola da 1/4".
- Acciaio speciale altamente legato al cromo vanadio.
- Esecuzione cromata.

€ 37,00

€ 25,90



YouTube

210 mm
di lunghezza

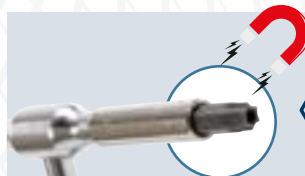

**PORTAINSERI
MAGNETICO DA 1/4"**

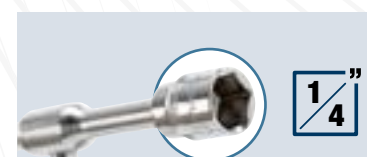

**ATTACCO QUADRO DA
1/4" PER BUSSOLE**

XGRIP

**VITI O DADI SPANATI?
NON BESTEMMIARE!**

Vai a pagina 4: abbiamo la soluzione per te!



YouTube

CHIAVI MASCHIO 280 T SICUREZZA GARANTITA.



ACCIAIO SPECIALE
al cromo vanadio.



CHIAVI USAG **ALTRE CHIAVI**

SICUREZZA GARANTITA

- +30% resistenza alla torsione rispetto alla norma ISO 2936.
- Raggiunta la coppia di rottura, la chiave si deforma senza spezzarsi.

TRAVERSINO FISSO

Massima resistenza.



7
PEZZI



280 T/SE7

U02800903

Serie di 7 chiavi a T con maschio esagonale

- 280 T/2-2,5-3-4-5-6-8 mm.

~~€ 119,00~~

€ 83,50

8
PEZZI



280 TTX/SE8

U02800686

Serie di 8 chiavi a T per viti con impronta TORX®

- 280 TTX/T6-T7-T8-T9-T10-T15-T20-T25.

~~€ 169,00~~

€ 119,00

6
PEZZI



280 TTS/SE6

U02800760

Serie di 6 chiavi a T maschio esagonali con testa sferica

- 280 TTS/2,5-3-4-5-6-8 mm.

~~€ 105,00~~

€ 73,00



Testa sferica

6
PEZZI



280 TK/SE6

U02800020

Serie di 6 chiavi a T maschio esagonale con traversino scorrevole

- 280 TK/2,5-3-4-5-6-8 mm.

~~€ 113,00~~

€ 79,00

Traversino scorrevole



CHIAVI MASCHIO 280 HG CON IMPUGNATURA ERGONOMICA.



SICUREZZA GARANTITA

- +30% resistenza alla torsione rispetto alla norma ISO 2936.
- Raggiunta la coppia di rottura, la chiave si deforma senza spezzarsi.

Stessa lama
delle chiavi 280 T



IMPUGNATURA BIMATERIALE
ERGONOMICA.

ACCIAIO SPECIALE
AL CROMO VANADIO.



6
PEZZI



280 HG/SE6
U02801460

Serie di 6 chiavi maschio esagonale con impugnatura
• 280 HG/2,5-3-4-5-6-8 mm.

~~€ 79,00~~

€ 55,00



6
PEZZI



280 HGTS/SE6
U02801463

Serie di 6 chiavi maschio esagonale a testa sferica con impugnatura
• 280 HGTS/2,5-3-4-5-6-8 mm.

~~€ 87,00~~

€ 61,00



Testa
sferica



6
PEZZI



280 HAP/SE6
U02800462

Serie di 6 chiavi maschio esagonale in pollici con impugnatura
• 280 HAP/1/4-7/32-5/32-5/16-3/8-3/16".

~~€ 78,00~~

€ 54,50



6
PEZZI



280 HATX/SE6
U02800464

Serie di 6 chiavi maschio con impugnatura per viti con impronta TORX®
• 280 HATX/T8-T10-T15-T20-T25-T30.

~~€ 61,00~~

€ 42,70



Inserti e chiavi maschio



32
PEZZI



YouTube



692 J32

U06920042

Assortimento di inserti con cricchetto

DESCRIZIONE	MISURA	PZ.
Inserti ad intaglio	4-5,5-6,5-8	4
Inserti a croce PHILLIPS®	PH 1-2-3	3
Inserti a croce POZIDRIV®	PZ 1-2-3	3
Inserti esagono maschio	3-4-5-6	4
Inserti TORX®	T8-10-15-20-20-25-25-30-40	9
Inserti TORX® Tamper Resistant	STX 10-15-20-25-27-30-40	7
Portainseri magnetico		1
Cricchetto		1

~~€ 55,00~~

€ 38,50



49
PEZZI



YouTube



692 J49

U06920041

Assortimento di inserti

DESCRIZIONE	MISURA	PZ.
Inserti ad intaglio	4-4,5-5,5-6,5-6,5-8	6
Inserti a croce PHILLIPS®	PH 1-1-2-2-2-3	6
Inserti a croce POZIDRIV®	PZ 1-1-2-2-2-3-3	7
Inserti esagono maschio	2-3-3-4-4-5-5-6-6	9
Inserti TORX®	TX 10-10-15-15-20-20-25-25-30-30	10
Inserti TORX® Tamper Resistant	STX 10-15-15-20-20-25-25-30-30-40	10
Portainseri magnetico		1

~~€ 42,60~~

€ 29,80



Riconoscimento dell'inserto con codice colore per una scelta rapida



-----50 mm-----



664 S25

U06640111

25
PEZZI



Assortimento di inserti per avvitatura

- Fornito in cassetta di plastica

DESCRIZIONE	MISURA	PZ.
Inserti lunghi ad intaglio	3-4-5-6	4
Inserti lunghi a croce PH	1-2(x2)-3(x1)	5
Inserti lunghi a croce PZ	1-2(x2)-3(x1)	5
Inserti lunghi TORX®	T15-T20-T25-T30-T40	5
Inserti lunghi esagonali	2-3-4-5-5,5	5
Portainseri magnetico		1

~~€ 68,50~~

€ 47,90

664 B/S7

U06640015

Assortimento di inserti a bussola

- Fornito in cassetta di plastica

~~€ 36,70~~

€ 25,70



7
PEZZI



5,5-6-7-8
10-12-13 mm





900 g | 215 mm | 45 mm | 150

DESCRIZIONE	MISURA	PZ.
Inserti a intaglio	3-4-4,5-5-5,5-6-6,5-7-8	9
Inserti a croce	PH 00-0-1-1-2-2-3-4 PZ 1-2-2-3-4	13
Inserti esagono maschio	1,5-2-2,5-3-4-5-5,5-6-7-8 mm 1/16-5/64-3/32-7/64-1/8-9/64-5/32-3/16-7/32-1/4"	20
Inserti TORX®	T 8-9-10-15-20-25-27-30-40-45	10
Inserti TORX® Tamper Resistant	STX 8-10-15-20-25-27-30-35-40	9
Inserti Tri-Wing	1-2-3-4	4
Inserti Spanner	4-6-8-10-12	5
Inserti Torq-set	6-8-10	3
Inserti quadrati	0-1-2-2-3	5
Inserti Clutch	1/8-5/32-3/16-1/4-5/16	5
Inserti XZN	M5-M6-M8	3
Inserti esagono maschio con foro	2-2,5-3-4-5-6 mm - 5/64-3/32-7/64-1/8-9/64-5/32"	12
Portainseri magnetici	1/4x60mm	2

692 J100
U06920043

Assortimento di inserti con impronte speciali

~~€ 65,50~~

€ 45,80

100
PEZZI

1/4



SUPPORTI COMPATTI CON SISTEMA DI ESTRAZIONE RAPIDA



Guarda il video dimostrativo



YouTube



9
PEZZI



280 LTS/S9
U02800084

Serie di 9 chiavi maschio esagonale lunghe testa sferica

- 280 LTS/1,5-2-2,5-3-4-5-6-8-10 mm.

~~€ 33,90~~

€ 21,50



8
PEZZI



280 LTSTX/S8
U02800078

Serie di 8 chiavi maschio lunghe testa sferica TORX®

- 280 LTSTX/T10-T15-T20-T25-T27-T30-T40-T45.

~~€ 61,50~~

€ 43,00



9
PEZZI



280 XLTS/S9
U02800184

Serie di 9 chiavi maschio esagonale extra-lunghe a testa sferica

- 280 XLTS/1,5-2-2,5-3-4-5-6-8-10 mm.

~~€ 37,60~~

€ 26,40

GAMMA PINZE "AX" FINITURA CROMATA ED IMPUGNATURE BIMATERIALE.



Taglia fino a Ø 2 mm di filo armonico con il 30% in meno di forza rispetto al valore massimo indicato dalle normative europee ISO5749 (tronchesi) - ISO5746 (pinze).

YouTube



TAGLIENTI TEMPRATI AD INDUZIONE
per la massima efficacia nel taglio del filo armonico.



FULCRO PIÙ VICINO AI TAGLIENTI
per il minimo sforzo durante il taglio.

IMPUGNATURE ERGONOMICHE BIMATERIALE

IMPUGNATURA USAG



- SFORZO

PRODOTTI SUL MERCATO



+ SFORZO

Minimo sforzo risultante dagli studi sugli sforzi muscolari effettuati dal prestigioso istituto americano US Ergonomics.

3 PEZZI



150 AX/SE3
U01500201

Assortimento pinze e tronchesi

- Pinza universale 150 AX 180.
- Pinza a becchi mezzotondi lunghissimi diritti 133 AX 160.
- Tronchese a grande effetto a tagliente diagonale 188 AX 160.

~~€ 96,50~~

€ 68,00

3 PEZZI



1000 V

085 EX/SE3
U00850121

Assortimento pinze e tronchesi isolati 1000 V

- Pinza universale 085 EX 180.
- Pinza a becchi mezzotondi lunghissimi diritti 081 EX 160.
- Tronchese a grande effetto a tagliente diagonale 087 EX 160.

~~€ 130,00~~

€ 91,00



PROFILI TONDI

Intaglio ricavato nella dentatura per una presa sicura di barre tonde, anche filettate.

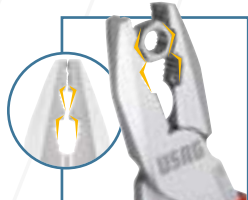

PROFILI ESAGONALI

Geometria delle ganasce studiata per la presa di un esagono.



155 AX
U01550001

Pinza universale multifunzione

~~€ 59,50~~

€ 39,00

Pinza multifunzione



CAPACITÀ MAX.
80 mm

135 B
U01350510

Pinza regolabile autobloccante a cremagliera con ganasce lunghe

- Ganasce forgiate.
- Dentatura studiata per una presa perfetta anche su tondo.
- Sistema di apertura brevettato ed integrato nei manici.
- Rullino di regolazione della presa integrato sul manico superiore.
- Cremagliera a 5 posizioni.

~~€ 75,50~~

€ 53,00



CAPACITÀ MAX.
135 mm

135 C
U01350530

Pinza regolabile autobloccante a cremagliera a grande capacità

- Ganasce forgiate.
- Dentatura studiata per una presa perfetta anche su tondo.
- Sistema di apertura brevettato ed integrato nei manici.
- Rullino di regolazione della presa integrato sul manico superiore.
- Cremagliera a 5 posizioni.

~~€ 92,00~~

€ 64,00



TAGLIO RASO



**PER MATERIALE
PLASTICO**

186 C

Tronchesi a tagliente raso diagonale per materiali plastici

- Becchi arrotondati ribassati.
- Molla di richiamo.
- Manici rivestiti con guaina in PVC.
- Corpo in acciaio speciale altamente legato al cromo vanadio.
- Esecuzione brunita testa pulita.

CODICE	L	TAGLIENTI
--------	---	-----------

U01860060	150 mm	22 mm
-----------	--------	-------

~~€ 38,50~~

€ 23,90

U01860061	180 mm	27 mm
-----------	--------	-------

~~€ 43,30~~

€ 27,30



**TAGLIO RASO
PIEGATO A 45°**



**PER MATERIALE
PLASTICO**

187 C

U01870001

Tronchese a tagliente raso diagonale piegato a 45° per materiali plastici

- Becchi arrotondati ribassati.
- Molla di richiamo.
- Manici rivestiti con guaina in PVC.
- Corpo in acciaio speciale altamente legato al cromo vanadio.
- Esecuzione brunita testa pulita.

~~€ 58,00~~

€ 40,50

**PERFETTI PER IL TAGLIO PIANO E A FILO DELLE SUPERFICI
DELLE MATEROZZE, TIPICO DELLO STAMPAGGIO A INIEZIONE**

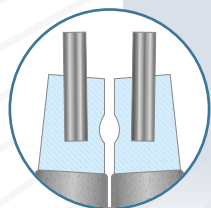

MASSIMA RESISTENZA

Punte in acciaio armonico inserite nei becchi.

4 PEZZI



127 N/SE4S
U01270046

10÷25 mm

Serie 4 pinze per anelli elastici

- Pinze per anelli elastici interni **127 N** 12÷25-**127 PN** 12÷25.
- Pinze per anelli elastici esterni **128 N** 10÷25-**128 PN** 10÷25.

~~€ 97,50~~

€ 68,50

127 N/SE4
U01279000P

19÷60 mm

Serie 4 pinze per anelli elastici

- Pinze per anelli elastici interni **127 N** 19÷60-**127 PN** 19÷60.
- Pinze per anelli elastici esterni **128 N** 19÷60-**128 PN** 19÷60.

~~€ 106,00~~

€ 74,00

127 C/SE4S
U01270045

10÷25 mm

Serie 4 pinze per anelli elastici

- Pinze per anelli elastici interni **127 C** 12÷25-**127 CP** 12÷25.
- Pinze per anelli elastici esterni **128 C** 10÷25-**128 CP** 10÷25.

~~€ 81,00~~

€ 56,50

127 C/SE4
U01270040

19÷60 mm

Serie 4 pinze per anelli elastici

- Pinze per anelli elastici interni **127 C** 19÷60-**127 CP** 19÷60.
- Pinze per anelli elastici esterni **128 C** 19÷60-**128 CP** 19÷60.

~~€ 88,50~~

€ 62,00

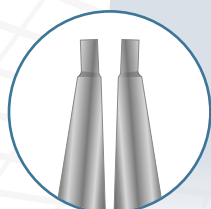

MASSIMA ACCESSIBILITÀ

Punte e becchi in corpo unico.

4 PEZZI

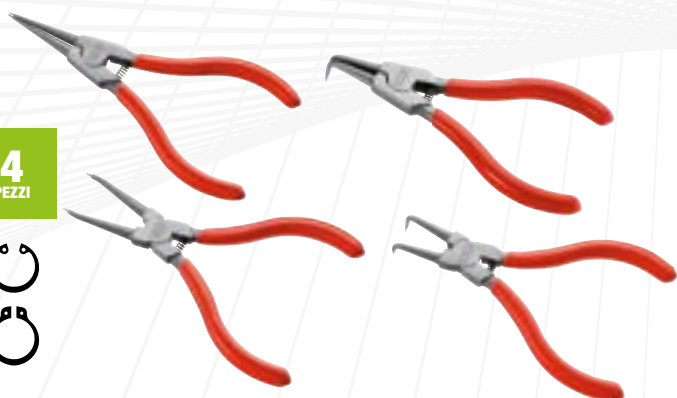

127 C/SE4P
U01270060

3÷10 mm



Serie 4 pinze per anelli elastici

- Pinze per anelli elastici interni **127 C** 3÷10-**127 CP** 3÷10.
- Pinze per anelli elastici esterni **128 C** 3÷10-**128 CP** 3÷10.

~~€ 81,00~~

€ 56,50

127 C/SE4M
U01270065

40÷100 mm



Serie 4 pinze per anelli elastici

- Pinze per anelli elastici interni **127 C** 40÷100-**127 CP** 40÷100.
- Pinze per anelli elastici esterni **128 C** 40÷100-**128 CP** 40÷100.

~~€ 112,00~~

€ 78,50

PINZE A CREMAGLIERA PER ANELLI ELASTICI



MECCANISMO A CREMAGLIERA

che consente di rimuovere o installare senza sforzo e con precisione, anelli elastici di grandi dimensioni

FINITURA CROMATA

MANICI RIVESTITI IN PVC

85÷200 mm

PUNTE RIMOVIBILI E INTERCAMBIABILI

fissate tramite grano con esagono da 5 mm



127 M
U01270051

Pinza a cremagliera a becchi diritti per anelli elastici interni di grandi dimensioni

~~€ 80,00~~

€ 56,00

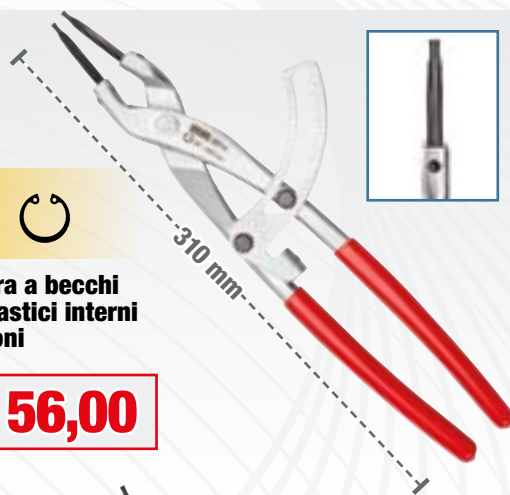

127 MP
U01270050

Pinza a cremagliera a becchi piegati a 45° per anelli elastici interni di grandi dimensioni

~~€ 80,00~~

€ 56,00



128 M
U01280051

Pinza a cremagliera a becchi diritti per anelli elastici esterni di grandi dimensioni

~~€ 80,00~~

€ 56,00



128 MP
U01280050

Pinza a cremagliera a becchi piegati a 45° per anelli elastici esterni di grandi dimensioni

~~€ 80,00~~

€ 56,00

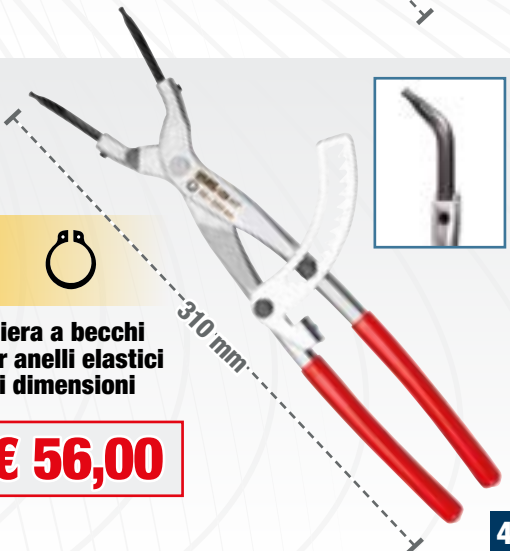

PINZA CHIAVE 174 CX

PINZA E CHIAVE IN UN UNICO UTENSILE.



**SISTEMA
DI CHIUSURA RAPIDA**
senza premere il pulsante.



BECCHI PIATTI E PARALLELI
Battuta sagomata
per far presa su 4 lati dell'esagono.



GANASCE SOTTILI

**CAPACITÀ MAX.
58 mm**



YouTube

SCALA MILLIMETRATA

**CREMAGLIERA CON
20 POSIZIONI**

**MANICI RIVESTITI
IN PVC**

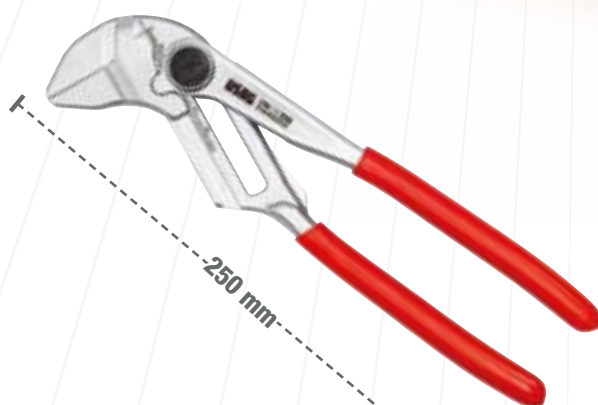

174 CX
U01740001

Pinza chiave regolabile
• Lunghezza 250 mm.

€ 74,00

€ 52,00

**APERTURA
MAGGIORATA +20%**



YouTube

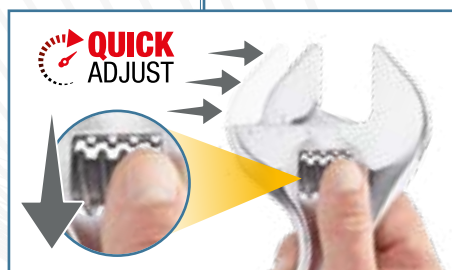

**ARRETRI IL RULLINO,
REGOLI RAPIDAMENTE.**

**RUOTI IL RULLINO,
REGOLI CON PRECISIONE.**

294 AD

Chiavi a rullino con regolazione rapida

- Si regola rapidamente arretrando il rullino.
- Grande capacità: apertura +20% rispetto allo standard.
- Doppia scala graduata: millimetri e pollici.
- Testa inclinata di 22°.
- Rullino in acciaio.
- Asola di aggancio.
- Finitura cromata.

CODICE	L	APERTURA	€	€
U02940011	110 mm - 4"	17 mm	€19,30	€ 13,50
U02940012	150 mm - 6"	23 mm	€20,30	€ 14,20
U02940013	200 mm - 8"	33 mm	€24,20	€ 17,00
U02940014	250 mm - 10"	38 mm	€30,70	€ 21,50
U02940015	300 mm - 12"	41 mm	€40,40	€ 28,30
U02940016	380 mm - 15"	50 mm	€74,00	€ 52,00
U02940017	460 mm - 18"	63 mm	€122,00	€ 85,50

**APERTURA
MAGGIORATA +20%**



YouTube



INVERTI

LA GANASCIA MOBILE
per passare dalla presa su esagono a quella su tondo.

**POSIZIONE
STANDARD**

**GANASCIA
INVERTITA**

294 AG

Chiavi a rullino reversibili con impugnatura

- Nella posizione standard può manovrare un profilo esagonale.
- Invertendo il dente mobile, può manovrare un profilo tondo.
- Grande capacità: apertura +20% rispetto allo standard.
- Doppia scala graduata: millimetri e pollici.
- Impugnatura ergonomica bimateriale.
- Testa inclinata di 22°.
- Rullino in acciaio.
- Asola di aggancio.
- Finitura cromata.

CODICE	L	APERTURA	€	€
U02940023	200 mm - 8"	33 mm	€26,50	€ 18,60
U02940024	250 mm - 10"	38 mm	€33,80	€ 23,60
U02940025	300 mm - 12"	41 mm	€44,40	€ 31,10

**APERTURA
MAX 34 mm**



-46%

**LUNGHEZZA RIDOTTA
DEL 46% RISPETTO AD
UNA CHIAVE STANDARD**

294 AC

U02940010

Chiave regolabile a rullino corta

- Lunghezza ridotta del 46% rispetto ad una chiave standard.
- Apertura ganasce pari ad una chiave a rullino da 12".
- Leggera e compatta per un'ottima accessibilità.
- Regolazione tramite rullino in acciaio.
- Scala millimetrata sulla testa della chiave.
- Finitura cromata.

~~€ 24,10~~

€ 16,90

CHIAVE A CRICCHETTO 285 KA CON ANELLO DI TENUTA INTEGRATO.



SEZIONE A DOPPIA T

Massima resistenza alla flessione.

POSIZIONE OTTIMALE



ANELLO IN ACCIAIO ARMONICO INTEGRATO NELL'OCCHIO POLIGONALE

Mantiene la posizione sul dado durante la manovra.



FORCHETTA CON SISTEMA ANTISLITTAMENTO DEL DADO

Maggiore tenuta durante la manovra.

CRICCHETTO RESISTENTE

Resistenza alla torsione statica del cricchetto: **+50% rispetto alla norma ISO 1711-1.**



YouTube

8

PEZZI



8÷19 mm



285 KA/DS8

U02856058

Serie di 8 chiavi combinate a cricchetto con anello di tenuta

- 285 KA/8-10-11-12-13-14-17-19 mm.
- Fornita con supporto in plastica.

€ 157,00

€ 105,00

12

PEZZI



7÷19 mm



285 KA/DS12

U02856062

Serie di 12 chiavi combinate a cricchetto con anello di tenuta

- 285 KA/7-8-10-11-12-13-14-15-16-17-18-19 mm.
- Fornita con supporto in plastica.

€ 238,00

€ 167,00

CHIAVE A CRICCHETTO SNODATA 285 KF



FORCHETTA CON SISTEMA ANTISLITTAMENTO DEL DADO

Maggiore tenuta durante la manovra.

SEZIONE A DOPPIA T

Massima resistenza alla flessione.

TESTA SNODATA

180°

5
PEZZI

8÷19 mm

285 KF/SE5
U02856160

Serie di 5 chiavi combinate a cricchetto snodate

- 285 KF/8-10-13-17-19 mm.

~~€ 111,00~~

€ 77,50

8
PEZZI

8÷19 mm

285 KF/DS8
U02856158

Serie di 8 chiavi combinate a cricchetto snodate

- 285 KF/8-10-11-12-13-14-17-19 mm.
- Fornita con supporto in plastica.

~~€ 184,00~~

€ 129,00

CHIAVE A CRICCHETTO PIATTA 285 KB



TESTA A CRICCHETTO PIATTA

per favorire l'accessibilità in punti difficili da raggiungere.



CAMBIO DEL SENSO DI ROTAZIONE

ribaltando la chiave di 180°.

7
PEZZI

8÷19 mm

285 KB/DS7
U02856341

Serie di 7 chiavi combinate a cricchetto piatte

- 285 KB/8-10-12-13-14-17-19 mm.
- Fornita con supporto in plastica.

~~€ 108,00~~

€ 75,00

12
PEZZI

8÷19 mm

285 KB/DS12
U02856342

Serie di 12 chiavi combinate a cricchetto piatte

- 285 KB/8-9-10-11-12-13-14-15-16-17-19 mm.
- Fornita con supporto in plastica.

~~€ 185,00~~

€ 127,00



YouTube

CHIAVE COMBINATA 285 RESISTENTE ED ERGONOMICA.

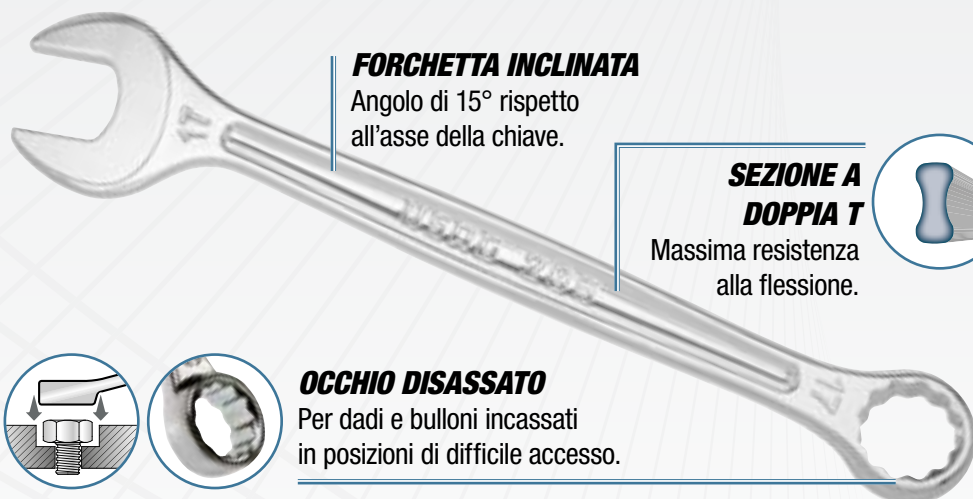

FORCHETTA INCLINATA

Angolo di 15° rispetto all'asse della chiave.

SEZIONE A DOPPIA T

Massima resistenza alla flessione.



OCCHIO DISASSATO

Per dadi e bulloni incassati in posizioni di difficile accesso.



TOP PERFORMANCE

Resistenza alla torsione statica di anello e forchetta: **+50%** rispetto alla norma ISO 1711-1.

ISO 1711-1
SAE AS 954E



8
PEZZI

8÷19 mm

285 DS8
U02850863

- Serie di 8 chiavi combinate**
- 285/8-10-11-12-13-14-17-19 mm.
 - Fornita con supporto in plastica.

€ 78,50

€ 51,00



12
PEZZI

7÷19 mm

285 DS12
U02850864

- Serie di 12 chiavi combinate**
- 285/7-8-10-11-12-13-14-15-16-17-18-19 mm.
 - Fornita con supporto in plastica.

€ 116,00

€ 79,00



MISURE IN POLLICI

1/4÷9/16"

285 P/SE5
U02850856

- Serie di 26 chiavi combinate in pollici**
- 285 P/ 1/4-3/8-7/16-1/2-9/16".

€ 45,40

€ 31,00

5
PEZZI



6÷32 mm

285 SE26
U02850861

- Serie di 26 chiavi combinate**
- 285/6-7-8-9-10-11-12-13-14-15-16-17-18-19-20-21-22-23-24-25-26-27-28-29-30-32 mm.

€ 347,00

€ 236,00

Just **USAG**

CHIAVE COMBINATA 285 J



FORCHETTA INCLINATA DI 15°



TESTA POLIGONALE PIEGATA DI 15°

7
PEZZI

8÷19 mm

285 J/DS7
U02851745

- Serie di 7 chiavi combinate**
- 285 J/8-10-12-13-14-17-19 mm.
 - Fornita con supporto in plastica.

~~€ 56,00~~

€ 39,00

12
PEZZI

8÷19 mm

285 J/DS12
U02851746

- Serie di 12 chiavi combinate**
- 285 J/8-9-10-11-12-13-14-15-16-17-19 mm.
 - Fornita con supporto in plastica.

~~€ 93,00~~

€ 59,00

8
PEZZI

6÷22 mm



252 N/SR8
U02520862

- Serie di 8 chiavi a forchetta doppie**
- 252 N/6x7-8x9-10x11-12x13-14x15-16x17-18x19-20x22 mm.

~~€ 60,00~~

€ 42,20

8
PEZZI

7÷19 mm

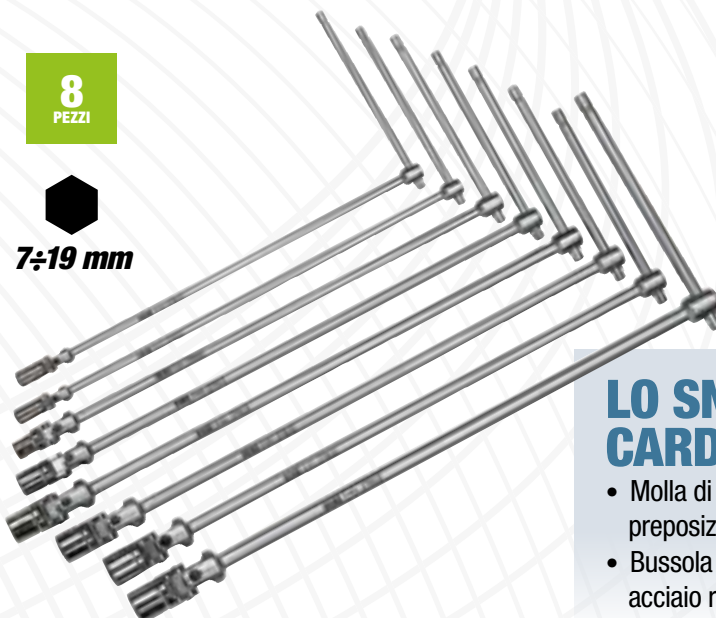

UNI 6743

276 CE/SE8
U02760484

- Serie di 8 chiavi a T snodate**
- 276 CE/7-8-10-12-13-14-17-19 mm.

~~€ 352,00~~

€ 245,00

LO SNODO CARDANICO USAG

- Molla di frizione interna per il perfetto preposizionamento della bussola.
- Bussola e cardano fissati con un perno in acciaio ribadito per la massima affidabilità.





16
PEZZI

1/4"

1/2"



1 kg | mm | 190
58
144

601 1/4-1/2" JTX16

U06010009

Assortimento in cassetta modulare con bussole TORX®

DESCRIZIONE	MISURA	PZ.
Chiavi a bussola 1/4 TORX®	E6-E7-E8-E10	4
Chiavi a bussola 1/2 TORX®	E12-E14-E16-E18	4
Chiavi a bussola 1/4 con inserto TORX®	T10-T15-T20-T25	4
Chiavi a bussola 1/2 con inserto TORX®	T30-T40-T45-T50	4

~~€ 41,00~~ **€ 28,80**



34
PEZZI

1/4"



1 kg | mm | 190
58
144

601 1/4" J34

U06010001

Assortimento in cassetta modulare con bussole esagonali ed inserti per avvitatura

DESCRIZIONE	MISURA	PZ.
Chiavi a bussola 1/4"	4-4,5-5-5,5-6-7-8-9-10-11-12-13-14	13
Cricchetto reversibile 1/4"		1
Snodo cardanico 1/4"		1
Prolunghe 1/4"	55-100	2
Inserti a intaglio	4-5,5-6	3
Inserti a croce POZIDRIV®	1-2-3	3
Inserti esagono maschio	4-5-6	3
Inserti TORX®	T10-T15-T20-T25-T30-T40	6
Impugnatura maschio/femmina		1
Raccordo portainseri 1/4"		1

~~€ 66,50~~ **€ 46,00**



22
PEZZI

1/2"



4 kg | mm | 375
80
186

601 1/2" J22

U06010003

Assortimento in cassetta modulare con bussole esagonali

DESCRIZIONE	MISURA	PZ.
Bussole esagonali 1/2"	8-10-11-12-13-14-15-16-17-18-19-21-22-24-27-30-32	17
Cricchetto 1/2"		1
Prolunghe 1/2"	130-250	2
Snodo cardanico 1/2"		1
Leva a T 1/2"		1

~~€ 116,00~~ **€ 75,00**

LA QUALITÀ **USAG** A UN PREZZO *Just*



1/4"

1/2"

8 kg | 415 mm | 92 | 283

100 PEZZI



601 1/4-1/2" J100  
U06010011

Assortimento in cassetta modulare con bussole esagonali ed inserti per avvitatura

~~€ 192,00~~

€ 129,00

Modulare con i cassetti dei carrelli USAG!

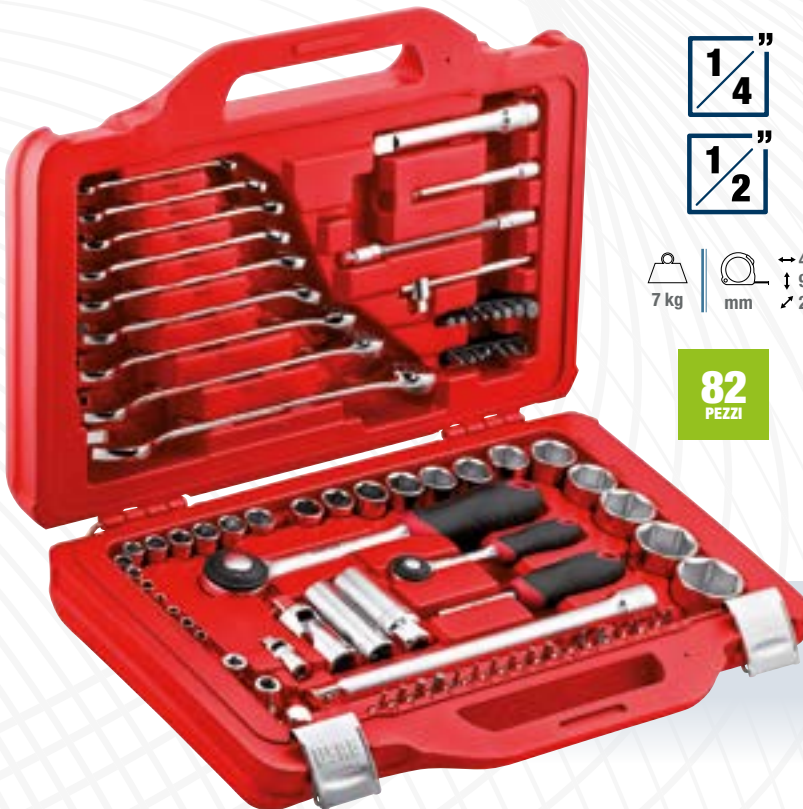

1/4"

1/2"

7 kg | 415 mm | 92 | 283

82 PEZZI



601 1/4-1/2" J82 
U06010010

Assortimento in cassetta modulare con bussole esagonali e chiavi combinate

~~€ 291,00~~

€ 149,00

Modulare con i cassetti dei carrelli USAG!



CRICCHETTO 237 A CON MECCANISMO SIGILLATO IP51.



Sistema di inversione integrato nel coperchio



Spessore della testa ridotto rispetto ai modelli standard -10%



YouTube



IMPUGNATURA CONICA
in bimateriale e antiscivolo.

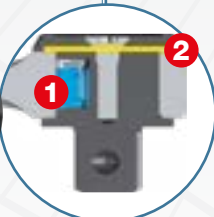

1. Nottolino brevettato.
2. Diaframma protettivo.

TOP PERFORMANCE

1. Resistenza alla torsione statica:
+30% di coppia rispetto alla norma ISO 3315 grazie al nottolino brevettato.
2. Resistenza a fatica:
dura il doppio dei normali cricchetti del mercato grazie alla protezione IP51.



23
PEZZI

1 1/2"



3 kg | 330 mm | 215

606 1/2" EA
U06060302

Assortimento in cassetta di ABS con bussole esagonali
• Cassetta in ABS ad alta resistenza con sistema di chiusura rapida.

DESCRIZIONE	ART./MISURA	PZ.
Chiavi a bussola con bocca esagonale	235 1/2 EN 8-9-10-11-12-13-14-15-16-17-18-19-21-22-23-24-27-30-32	19
Prolunghe	236 1/2 125-250	2
Snodo cardanico	241 1/2	1
Cricchetto reversibile certificato IP51	237 A 1/2	1

€ 254,00

€ 153,00



19
PEZZI

1 1/4"



1 kg | 210 mm | 130

606 1/4" EA
U06060101

Assortimento in cassetta di ABS con bussole esagonali
• Cassetta in ABS ad alta resistenza con sistema di chiusura rapida.

DESCRIZIONE	ART./MISURA	PZ.
Chiavi a bussola con bocca esagonale	235 1/4 EN 4-4,5-5-5,5-6-7-8-9-10-11-12-13-14	13
Prolunghe	236 1/4 50-100	2
Snodo cardanico	241 1/4	1
Leva a T con attacco quadro scorrevole	240 1/4	1
Portabussole con impugnatura	243 1/4	1
Cricchetto reversibile certificato IP51	237 A 1/4	1

€ 134,00

€ 80,00



YouTube



38
PEZZI

1/4"



900 g | 155 mm | 50 mm | 95 mm

609 1/4" EB 
U06090002

Assortimento con bussole esagonali ed inserti per avvitatura

• Cassetta compatta in bimatrimiale con rivestimento soft-touch.

DESCRIZIONE	ART./MISURA	PZ.
Bussole esagonali	235 1/4" EN 5,5-6-7-8-9-10-11-12-13-14 mm	10
Prolunghe	236 1/4" 50-100	2
Cricchetto reversibile	237 B 1/4"	1
Snodo cardanico	241 1/4"	1
Impugnatura porta-bussole	243 1/4"	1
Inserti ad intaglio	660 0,6x4,5-1x5,5-1,2x6,5	3
Inserti PH	660 PH 1-2-3	3
Inserti PZ	660 PZ 1-2-3	3
Inserti esagonali	660 E 2-3-4-5-6	5
Inserti Torx® Tamper Resistant	660 STX T10-T15-T20-T25-T27-T30-T40	7
Inserto porta-bussole	660 Q 1/4"	1
Bussola porta-inserti	684 1/4"-1/4"	1

~~€ 212,00~~

€ 148,00

CRICCHETTI CON IMPUGNATURA ROTANTE

1/4"

237 1/4" AK
U02370003

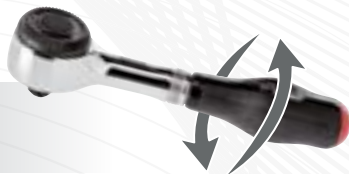

Cricchetto reversibile 1/4" con impugnatura rotante

~~€ 53,50~~

€ 37,40

1/2"

237 1/2" AK
U02370009



Cricchetto reversibile 1/2" con impugnatura rotante

~~€ 87,50~~

€ 61,00



17
PEZZI

3/4"



612 3/4" EB 
U06120017

13 kg | 425 mm | 83 mm | 395 mm

Assortimento in cassetta di lamiera con bussole esagonali

DESCRIZIONE	ART./MISURA	PZ.
Chiavi a bussola con bocca esagonale	235 3/4 N 22-23-24-26-27-28-30-32-36-38-41-46-50	13
Prolunghe	236 3/4 200-400	2
Leva a T scorrevole	240 3/4 N	1
Cricchetto reversibile con meccanismo sigillato 120 denti	237 B 3/4	1

~~€ 583,00~~

€ 407,00

612 3/4" B 
U06120016

**BUSSOLE
POLIGONALI**

Assortimento in cassetta di lamiera con bussole poligonali

~~€ 586,00~~

€ 407,00



YouTube



MINI KIT PER IL SERRAGGIO

Dimensioni compatte.
Prestazioni al top!

31 PEZZI

1/4"

350 g | mm | 120 / 30 / 60

180°

Inserto portabussole

606 1/4" SK U06060012

Assortimento inserti con cricchetto reversibile

DESCRIZIONE	ART./MISURA	PZ.
Cricchetto reversibile	237 1/4" SFK	1
Inserti ad intaglio	660 0,5x4-1x5,5	2
Inserti esagonali	660 E 1,5-2-2,5-3-4-5-6-7-8	9
Inserti a croce Phillips®	660 PH 1-2-3	3
Inserti a croce Pozidriv®- SUPadriv®	660 PZ 1-2-3	3
Raccordo portainseri	660 Q 1/4"	1
Inserti TORX® Tamper Resistant	660 STX T10-T15-T20-T25-T27-T30-T40	7
Inserti TORX®	660 TX T6-T7-T8-T9	4
Prolunga magnetica	672 1/4" MG 100	1

~~€ 73,50~~ € 51,50

610 1/4" EFK U06100001

Assortimento bussole ribassate con cricchetto reversibile



YouTube

11 PEZZI

1/4"

265 g | mm | 120 / 30 / 60

11 mm

5,5-6-7-8-9-10-11-12-13-14 mm

BUSSOLE ESAGONALI RIBASSATE

Garantiscono il doppio dell'accessibilità rispetto all'utilizzo di un cricchetto standard.



-50%

237 1/4" SK U02370062

Cricchetto reversibile con prolunga

- Testa snodata con movimento di 180°.
- Leva di inversione integrata.
- Funzione cricchetto: massima accessibilità grazie alla testa compatta ed allo snodo regolabile.
- Funzione chiave a T: la prolunga diventa un traversino e puoi usare il cricchetto come una chiave a T portainseri.

~~€ 36,00~~ € 25,00



1/4"



454

Estrattori a due bracci per esterni

CODICE	A	B	POTENZA			
U04540000	65 mm	70 mm	1,5 t	13 mm	€ 83,00	€ 58,00
U04540010	90 mm	110 mm	3 t	17 mm	€ 93,50	€ 65,50
U04540020	130 mm	110 mm	3 t	17 mm	€ 101,00	€ 70,50
U04540030	175 mm	165 mm	4 t	17 mm	€ 163,00	€ 114,00
U04540040	220 mm	165 mm	4 t	17 mm	€ 180,00	€ 126,00
U04540050	270 mm	220 mm	5 t	21 mm	€ 252,00	€ 176,00
U04540060	340 mm	220 mm	5 t	21 mm	€ 282,00	€ 197,00

**KIT COMPLETO
PER VITI E DADI
DANNEGGIATI**

**20
PEZZI**

↔ 210
↑ 60
mm ↗ 130



458 S20

U04580312

Assortimento di estrattori per viti e dadi esagonali danneggiati

DESCRIZIONE	ART./MISURA	PZ.
Estrattori per viti e dadi esagonali danneggiati	458 B 8-10-11-12-13-14-15-16-17-18-19	11
Estrattori per viti esagonali danneggiati	458 E 2-2,5-3-4-5-6-7-8	8
Bussola portainseriti	684 1/4	1

~~€ 210,00~~

€ 147,00



PROFILO ELICOIDALE PER DADI E VITI ESAGONALI

Le bussole elicoidali coniche garantiscono una presa esterna efficace su esagoni danneggiati.

COMPRESSE NEL PREZZO



**4
PEZZI**

451 N/S4

U04510100

Estrattore a tre bracci per esterni

- Modello a bracci autoserranti.
- Capacità: 7÷140 mm.
- Potenza: 3 ton.
- Spina di sicurezza.
- Vite di manovra con esagono da 18 mm.
- Possibilità di utilizzo a due bracci.
- Viti di manovra M16x2.

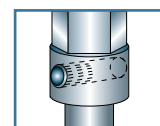

Spina di sicurezza: utilizzo sicuro e qualità dell'attrezzo preservata

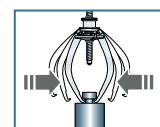

Autoserrante Autocentrante

~~€ 345,00~~

€ 175,00

**6
PEZZI**

Ø 1÷6 mm



230 g | ↔ 140
mm ↑ 47
↗ 133



458 S6

U04580012

Serie di 6 estrattori conici

- 458 1-2-3-4-5-6
- Per la rimozione di viti o prigionieri spezzati che non offrono possibilità di presa.
- Acciaio speciale altamente legato al cromo vanadio.
- Esecuzione satinata e brunita.
- Fornita in cassetta di materiale plastico.

~~€ 27,80~~

€ 19,50

BARRE DINAMOMETRICHE 811 LB

L'EQUILIBRIO PERFETTO TRA PRECISIONE E RESISTENZA.

ISO 6789

ATTACCO RAPIDO

9X12 o 14X18 per accessori e teste a cricchetto.

SCALA GRADUATA

incisa sul tubo in acciaio.

NONIO

in acciaio.

GHIERA DI REGOLAZIONE

con ritorno automatico.

MECCANISMO A SCATTO

con molla di compressione.

IMPUGNATURA

in bimatereale antiscivolo.

Precisa
± 2%

**PRECISIONE TESTATA
IN FABBRICA.**

Resistente
50.000 scatti

**TEST DI RESISTENZA
DEL MECCANISMO.**

Come da Normativa ISO 6789, le barre dinamometriche USAG 811 LB sono testate una ad una in produzione, prima di essere confezionate.

Queste barre riescono a mantenere una soglia di precisione tra il ±2% ed il ±4% anche dopo 5.000 serraggi.



YouTube



**SERRAGGI
DESTROSI
E SINISTRORSI**

PRECISIONE
±2%

811 LB

Barre dinamometriche a scatto

ARTICOLO	CODICE	CAPACITÀ	□	L	RISOL.		
811 LB 50	U08115021	10÷50 Nm	9x12 mm	357 mm	1 Nm	€ 285,00	€ 199,00
811 LB 100	U08115023	20÷100 Nm	9x12 mm	437 mm	1 Nm	€ 328,00	€ 229,00
811 LB 200	U08115024	40÷200 Nm	14x18 mm	515 mm	1 Nm	€ 342,00	€ 239,00
811 LB 350	U08115025	70÷350 Nm	14x18 mm	725 mm	2 Nm	€ 399,00	€ 279,00



**SERRAGGI
DESTROSI
E SINISTRORSI**

PRECISIONE
±2%

3/8"

1/2"

811 LBE

Chiavi dinamometriche a scatto con cricchetto reversibile amovibile

ARTICOLO	CODICE	CAPACITÀ	□	□	L	RISOL.		
811 LBE 50	U08115026	10÷50 Nm	3/8"	9x12 mm	407 mm	1 Nm	€ 365,00	€ 255,00
811 LBE 100B	U08115027	20÷100 Nm	3/8"	9x12 mm	487 mm	1 Nm	€ 408,00	€ 285,00
811 LBE 100C	U08115028	20÷100 Nm	1/2"	9x12 mm	487 mm	1 Nm	€ 410,00	€ 287,00
811 LBE 200	U08115029	40÷200 Nm	1/2"	14x18 mm	565 mm	1 Nm	€ 429,00	€ 300,00
811 LBE 350	U08115032	70÷350 Nm	1/2"	14x18 mm	775 mm	2 Nm	€ 486,00	€ 340,00

CHIAVI DINAMOMETRICHE 810 SA - 811 SA CON LETTURA DIRETTA DELLA COPPIA DI SERRAGGIO.

CRICCHETTO REVERSIBILE
con meccanismo a 72 denti.

ISO 6789



YouTube

MECCANISMO A SCATTO
con molla di compressione.

IMPUGNATURA CONICA
in bimatereale e antiscivolo.

LETTURA DIRETTA

Il valore della coppia impostato è subito visibile.

REGOLAZIONE RAPIDA

Imposti il valore di coppia necessario ancora più velocemente.



810 SA

Chiave dinamometrica a lettura diretta con cricchetto reversibile

- Include certificato di taratura e dichiarazione REACH (SVHC).

ARTICOLO	CODICE	CAPACITÀ	☑	L (mm)	RISOL.	€	€
810 SA 50	U08105002	10÷50 Nm	3/8"	350	0,25	€211,00	€ 147,00
810 SA 100	U08105003	20÷100 Nm	1/2"	410	0,5	€211,00	€ 147,00
810 SA 200	U08105005	40÷200 Nm	1/2"	475	1,0	€211,00	€ 147,00
810 SA 340	U08105006	60÷340 Nm	1/2"	630	1,0	€242,00	€ 170,00

PRECISIONE
±4%

3/8"

1/2"

**SERRAGGI
DESTRORSI**

811 SE

Chiave dinamometrica a lettura diretta con cricchetto amovibile

- Include certificato di taratura e dichiarazione REACH (SVHC).

ARTICOLO	CODICE	CAPACITÀ	☑	☐	L (mm)	RISOL.	€	€
811 SE 50	U08115012	10÷50 Nm	3/8"	9x12	370	0,25	€271,00	€ 190,00
811 SE 100B	U08115013	20÷100 Nm	3/8"	9x12	430	0,5	€271,00	€ 190,00
811 SE 100C	U08115015	20÷100 Nm	1/2"	9x12	430	0,5	€273,00	€ 191,00
811 SE 200	U08115017	40÷200 Nm	1/2"	14x18	510	1,0	€278,00	€ 194,00
811 SE 340	U08115018	60÷340 Nm	1/2"	14x18	665	1,0	€310,00	€ 216,00

PRECISIONE
±4%

3/8"

1/2"

Cricchetto amovibile

**SERRAGGI
DESTRORSI
E SINISTRORSI**



**SERRAGGI
DESTROSI**

PRECISIONE
±4%

1/4"



**SERRAGGI
DESTROSI
E SINISTRORSI**

Cricchetto
amovibile

PRECISIONE
±4%

1/4"



**SERRAGGI
DESTROSI
E SINISTRORSI**

PRECISIONE
±4%

3/4"

1/4"

PRECISIONE
±6%



810 N

ISO 6789

Chiave dinamometrica con cricchetto reversibile

- Meccanismo a scatto con molla di compressione.
- Riarmo automatico: dopo lo scatto è subito pronta all'uso.
- Fornita con certificato di collaudo.

ARTICOLO	CODICE	CAPACITÀ	□	L	RISOL.		
810 N 5	U08104000	1÷5 Nm	1/4"	197 mm	0,05	€ 231,00	€ 147,00
810 N 25	U08104001	5 ÷ 25 Nm	1/4"	290 mm	0,05	€ 231,00	€ 147,00

811 NE

ISO 6789

Chiave dinamometrica con cricchetto reversibile amovibile

- Cricchetto amovibile e sostituibile con gli inserti della gamma 811.
- Meccanismo a scatto con molla di compressione.
- Riarmo automatico: dopo lo scatto è subito pronta all'uso.
- Fornita con certificato di collaudo.

ART.	CODICE	CAPACITÀ	□	○	L	RISOL.		
811 NE 5	U08114009	1÷5 Nm	1/4"	9x12 mm	185 mm	0,05	€ 269,00	€ 189,00
811 NE 25	U08114010	5÷25 Nm	1/4"	9x12 mm	300 mm	0,05	€ 274,00	€ 192,00

812 N

ISO 6789

Chiavi dinamometriche con cricchetto reversibile

- Modelli a coppia regolabile per serraggi destrorsi e sinistrorsi con rotazione del cricchetto di 180°.
- Precisione ±4% del valore di coppia impostato.
- Scala di lettura in Nm.
- Meccanismo a scatto con molla di compressione.
- Riarmo automatico: dopo lo scatto è subito pronta all'uso.
- Blocco di sicurezza dopo la regolazione della coppia.
- Fornita in cassetta completa di certificato di collaudo.

ARTICOLO	CODICE	CAPACITÀ	□	○			
812 N 600	U08120006	120 ÷ 600 Nm	3/4"	14x18 mm		€ 1.065,00	€ 746,00
812 N 1000	U08120010	200 ÷ 1000 Nm	3/4"	-		€ 1.332,00	€ 933,00

824 A

ISO 6789

Giraviti dinamometrici

- Modello a coppia regolabile per serraggi destrorsi da utilizzare in abbinamento agli inserti della serie 660 o, tramite raccordo, alle chiavi a bussola della serie mano da 1/4".
- Scala di lettura in Nm.
- Disinnesto automatico al raggiungimento della coppia impostata.
- Riarmo automatico dopo 120°.
- Fornito con chiave di regolazione e certificato di collaudo.

CODICE	CAPACITÀ	L	RISOL.		
U08240004	0,5÷2,5 Nm	145 mm	0,1	€ 255,00	€ 179,00
U08240006	2÷10 Nm	167 mm	0,5	€ 261,00	€ 182,00

FORBICE 207 E CON STRUTTURA INTEGRALE IN ACCIAIO INOX.



YouTube



**L'UNICA CON STRUTTURA
INTEGRALE IN ACCIAIO INOX**
resiste alla flessione fino a 180 kg.

**SPELLAFILI
INTEGRATO**



1. Spellatura.
2. Crimpatura.

**TAGLIACAVI SU
ENTRAMBE LE LAME**



Adatto per cavi
multipolari.

**LAMA MICRODENTATA
ANTISCIVOLO**



207 E
U02070006

Forbice professionale per elettricisti

€ 42,40

€ 29,50

FORBICE 207 D

IL RIFERIMENTO PER GLI ELETTRICISTI.



**IMPUGNATURA
RESISTENTE ALLA
FLESSIONE FINO A 80 kg**
in tecnopolimero caricato vetro.

**ASOLE
MAGGIORATE**

207 D
U02070008

Forbice professionale
per elettricisti

€ 26,50

€ 18,60



50 mm²

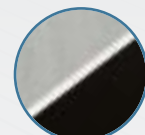

LAME FLUIDE E ROBUSTE

In acciaio inox con
microdentatura e tagliacavi.



YouTube

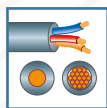

0,02÷10 mm²



146 A
U01460003

Pinza spellafili automatica dritta

- Funzioni di taglio e spellatura dei fili elettrici.
- Capacità 0,02-10 mm²/AWG 34-80.
- Ganasce intercambiabili senza uso di utensili.
- Tagliafili integrato nel corpo dell'utensile.
- Regolazione precisa del diametro di spellatura per evitare il danneggiamento dei conduttori.
- Lunghezza di spellatura regolabile.
- Dopo ogni singola spellatura, la ganasce si apre automaticamente per facilitare l'estrazione del filo.
- Impugnatura ergonomiche bimatériauale.

~~€ 104,00~~

€ 73,00



0,5÷1-1,5-2,5-4-6 mm²

753 A
U07530003

Pinza per terminali a puntale

- Modello a cremagliera per ridurre lo sforzo di compressione
- Impugnatura ergonomiche in PVC che facilitano il serraggio con una mano sola.
- Matrice in acciaio inox a 5 impronte.
- Corpo in lamiera d'acciaio.

~~€ 103,00~~

€ 72,00



15÷25
WATT

MAX
495°C

063 W
U00630002

Saldatore a stilo per elettronici a doppia potenza

- Saldatore professionale per stagno.
- Commutatore di potenza a pulsante.
- Ideale per diversi tipi di applicazioni in campo elettrotecnico.
- Punta in acciaio ad alta durata.
- Corpo in materiale plastico resistente ad olii ed idrocarburi.
- Alimentazione 230V.
- Fornito con supporto da banco.

~~€ 67,00~~

€ 47,00



2011/65/UE
2012/19/EC

Isolati



Non isolati

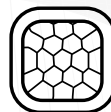

0,14÷10 mm²

753 KA
U07530004

Crimpatrice autoregolante per puntalini a sezione quadra

- Per puntalini isolati e non isolati.
- Capacità 0,14-10 mm²/AWG 26-8.
- Sistema di ripresa per operazioni multiple consecutive.
- Permette di crimpare applicando poca forza sulle impugnature.
- Peso ridotto e dimensioni compatte per maggiore maneggevolezza.

~~€ 243,00~~

€ 170,00

SMART FUNCTION

Selezione automatica della
tensione AC/DC, resistenza
e frequenza

MAX
600 V

RMS



074 A
U00740001

Multimetro digitale compatto SMART

- Misurazione di AC/DC.
- Misurazioni di resistenza e continuità (suono acustico se resistenza circuito è inferiore 40 a Ω).
- Misurazioni frequenza.
- Misurazione corrente AC/DC con pinza amperometrica 076 P.



CAT III 600V

CARATTERISTICHE TECNICHE

Tensione continua DC	1÷600 mV÷V
Tensione alternata AC	1÷600 mV÷V
Resistenza	0÷10 Ω ÷M Ω
Frequenza	3÷40 kHz
Tipo batterie (fornite)	2xAAA 1,5V

€ 150,00

€ 105,00



YouTube



\emptyset 4÷28 mm²



163

U01630001

Sguainacavi multifunzione

- Per il taglio circolare e longitudinale di cavi con rivestimento esterno in PVC.
- Sistema a grilletto (-30% di sforzo): forza necessaria 75 N.
- Rotella di avanzamento della lama.
- Lama di spellatura auto rotante.
- Blocco grilletto con lama estratta.
- Blocco di sicurezza della lama.
- Corpo ergonomico in materiale plastico.
- Lama di ricambio inclusa.
- Kit lame di ricambio codice 872272.

€ 41,80

€ 29,30



007 MV
U00070035

Marsupio portautensili (vuoto)

- Tessuto ad altissima resistenza.
- Sistema di fissaggio alla cintura con chiusura in velcro.
- 4 tasche portautensili elasticizzate.
- Gancio porta nastro.

€ 21,50

€ 15,00



007 MLV
U00070030

Marsupio portautensili con cintura (vuoto)

- Tessuto ad altissima resistenza.
- 6 tasche portautensili elasticizzate.
- Gancio porta nastro.
- Cintura regolabile da 80 a 120 cm.

€ 42,90

€ 30,00



305 N

Giratubi modello svedese con ganasce a 90° diritte

- Acciaio al cromo vanadio.

CODICE	CAPACITÀ	LUNGHEZZA		
U03050002	1"	40 mm	330 mm	€ 40,10 € 28,00
U03050003	1 1/2"	55 mm	420 mm	€ 53,50 € 37,50
U03050004	2"	67 mm	540 mm	€ 82,00 € 57,00
U03050005	3"	103 mm	690 mm	€ 123,00 € 86,00



RAME

314 DA

U03140033

Ø
3-35
mm

Ø
1/8-1 3/8
"

Tagliatubi per tubi in rame e lega leggera

- Modello ad avanzamento telescopico e ingombro costante.
- 4 rulli di scorrimento scanalati per il taglio di tubi bordati.
- Sostituzione rapida della rotella senza bisogno di utensili.
- Pomello ergonomico.

~~€ 74,00~~

€ 52,00



PLASTICA



317 K

U03170012

Ø
35
mm

Ø
1 9/8
"

Tagliatubi per tubi in plastica

- Per il taglio di tubi in PEX, PEHD, PVC, PER.
- Modello a cremagliera per un'azione di taglio progressiva con il minimo sforzo.
- Corpo in lega leggera.
- Esecuzione verniciata.

~~€ 58,00~~

€ 40,50



RAME

314 C

U03140032

Ø
3-30
mm

Ø
1/8-1 1/8
"

Tagliatubi per tubi in rame e lega leggera

- Rulli di scorrimento scanalati per il taglio di tubi bordati.
- Sostituzione rapida della rotella senza bisogno di utensili.
- Spessore massimo tubo: 2 mm.

~~€ 37,40~~

€ 26,00



PLASTICA



317 AM

U03170001

Ø
22
mm

Ø
7/8
"

Tagliatubi per tubi in PEX e plastica

- Lama con geometria speciale e rivestimento in PTFE.
- Ritorno automatico della lama.
- Sistema di chiusura con una sola mano.
- Dimensioni: 169x50x19 mm.

~~€ 43,70~~

€ 30,00



995 AF
U09950006

Rivettatrice con testa orientabile

- Capacità: Ø 2,4 - 3,2 - 4 - 4,8 mm (3/32 - 1/8 - 5/32 - 3,16").
- Testa orientabile liberamente a 360°.
- Adatta a rivetti in alluminio.
- 4 testine intercambiabili.
- Corpo in lega leggera.
- Clip in metallo per blocco apertura.
- Chiave smontaggio testine in dotazione.

~~€ 35,40~~

€ 24,80



995 A
U09950001

Rivettatrice

- Capacità acciaio: Ø 2,4 - 3,2 - 4 (3/32 - 1/8 - 5/32).
- Capacità alluminio: Ø 2,4 - 3,2 - 4 - 4,8 mm (3/32 - 1/8 - 5/32 - 3,16").
- Corpo in lega leggera.
- Leva di pressione in lamiera d'acciaio imbutita.
- Molla di richiamo per l'apertura dei manici.
- Fornita con 3 testine intercambiabili e chiave di servizio.

~~€ 33,00~~

€ 23,10



**-20%
DI SFORZO**

COMPATTA E POTENTE

Solo 330 mm di lunghezza 20% di sforzo in meno rispetto al modello standard.



**ALLUMINIO
E ACCIAIO**

995 LA
U09950004

Rivettatrice dritta compatta

- Capacità: Ø 2,4 - 3,2 - 4 - 4,8 - 6,4 mm (3/32 - 1/8 - 5/32 - 3,16 - 1/4").
- Modello compatto con la stessa capacità di una rivettatrice lunga standard.
- Il sistema di leve interno riduce lo sforzo dell'operatore.
- Adatta a rivetti in alluminio ed acciaio.
- 5 testine intercambiabili.
- Serbatoio amovibile per recupero steli.
- Corpo in lega leggera.

~~€ 62,50~~

€ 43,80



**Ø
M4 - M5
M6 - M8**

**FORNITA
IN CASSETTA**

**PER RIVETTI
FILETTATI**
(non inclusi)

995 CA
U09950008

Rivettatrice per inserti filettati

- Modello compatto con sistema di leve interno che garantisce meno sforzo all'operatore durante l'utilizzo.
- Fornita con 4 tiranti intercambiabili (M4-M5-M6-M8).
- Utilizzabile con rivetti in alluminio e acciaio (M4-M5-M6-M8) e acciaio inox (M4-M5).
- Corpo in lega leggera.
- Manici in materiale plastico.
- Fornita in valigetta di plastica (LxPxH: 320x175x50 mm) con vani portainseriti filettati (non inclusi).

~~€ 90,00~~

€ 63,00

LAME IN ACCIAIO INOX

211 A
U02110001

Forbice multiuso

- Lama con microdentatura antiscivolo.
- Leva per la selezione di mani piccole/grandi.
- Leva di sicurezza per il bloccaggio delle lame.
- Impugnature ergonomiche bimalteriali antiscivolo.

~~€ 23,40~~

€ 16,40



LAME IN ACCIAIO INOX

210 C
U02100003

Forbice multiuso

- Lama microdentata antiscivolo in acciaio inox.
- Grandi impugnature ergonomiche in bimalteriale.
- Perfetta per il taglio di alluminio, cartone, gomma, cuoio, moquette, ecc.

~~€ 20,60~~

€ 14,40

ADATTA PER DESTRIMANI



200 S
U02000002

Seghetto

- Anima in acciaio rivestita in materiale plastico antiscivolo ed antiurto.
- Fornito con lama al cobalto mod. 200 C24.

~~€ 35,90~~

€ 25,10

CAPACITÀ MAX 2 kg



442 TA
U04420013

Asta telescopica con terminale magnetico snodato

- Per il recupero di pezzi magnetizzabili da luoghi difficilmente accessibili.
- Materiale testa snodata: alluminio.

~~€ 14,00~~

€ 9,90

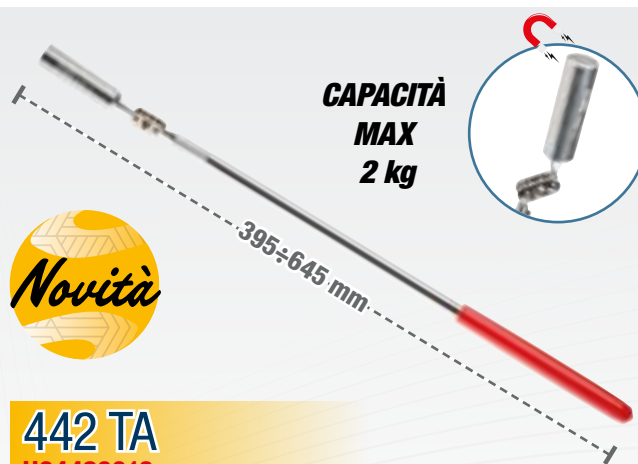

TAGLIENTE CENTRALE



196 N

Troncabulloni a tagliente centrale

CODICE	LUNGHEZZA	TAGLIO 2000 N/mm ² Ø MAX	TAGLIO 1600 N/mm ² Ø MAX	PESO	€	€
U01960002	450 mm	6 mm	7 mm	1,9 Kg	80,50	56,00
U01960003	600 mm	7 mm	10 mm	3,5 Kg	101,00	70,50
U01960004	750 mm	9 mm	13 mm	4,5 Kg	130,00	91,00
U01960005	900 mm	10 mm	16 mm	6,1 Kg	178,00	124,00
U01960006	1050 mm	11 mm	18 mm	8,3 Kg	262,00	183,00



TAGLIENTE SEMI RASO



196 NR
U01960001

Troncabulloni a tagliente semi raso

- Lama con taglianti ad alta resistenza.
- Impugnature in PVC.

~~€ 69,00~~

€ 48,00



2-3-4-5-6-8 mm

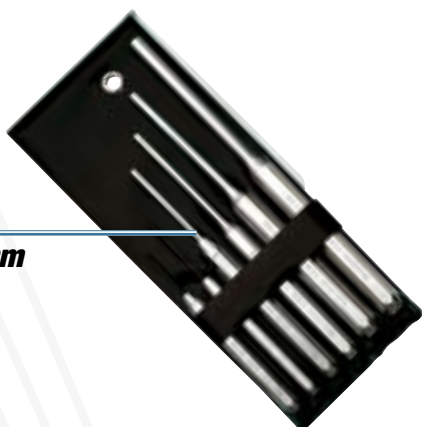

6
PEZZI

367 SE6

U03670081

Serie di 6 cacciaspine

- 367/2x100-3x130-4x145-5x165-6x180-8x200 mm.
- Fornita in busta di plastica.
- Acciaio al cromo vanadio.
- Punte riportate e fosfatate per le misure da 2 e 3 mm.

€ 56,50

€ 39,60

UNI 7784

376

Mazzuole

- Modello a tasselli intercambiabili in materiale plastico.
- Corpo in acciaio al carbonio.
- Manico in frassino.

CODICE	Ø TASSELLI	LUNGHEZZA	€	€
U03760001	22 mm	250 mm	€ 14,10	€ 9,85
U03760002	28 mm	275 mm	€ 17,10	€ 12,00
U03760003	35 mm	300 mm	€ 21,60	€ 15,20
U03760004	42 mm	325 mm	€ 29,10	€ 20,50
U03760005	50 mm	350 mm	€ 40,00	€ 28,00
U03760006	60 mm	380 mm	€ 58,00	€ 40,40

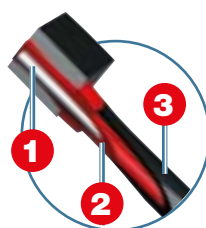

**MATERIALI COMBINATI
PER UN RISULTATO OTTIMALE.**

- 1** Anima in grafite: massima resistenza alla flessione.
- 2** Elevata qualità: corpo in polipropilene che assorbe le vibrazioni.
- 3** Rivestimento in gomma resistente agli idrocarburi.



DIN 1041

382 F

Martelli per meccanici manico in graphite

- Modello tedesco a testa quadra piana e penna simmetrica.
- Manico in graphite.

CODICE	PESO TESTA	LUNGHEZZA	€	€
U03820102	200 g	285 mm	€ 19,30	€ 13,50
U03820103	300 g	300 mm	€ 20,80	€ 14,60
U03820105	500 g	310 mm	€ 23,50	€ 16,40
U03820107	800 g	350 mm	€ 29,00	€ 20,30
U03820108	1000 g	355 mm	€ 31,50	€ 22,00

CODICE	PESO TESTA	LUNGHEZZA	€	€
U03820002	100 g	260 mm	€ 11,10	€ 8,15
U03820004	200 g	280 mm	€ 12,20	€ 8,55
U03820006	300 g	300 mm	€ 13,50	€ 9,45
U03820007	400 g	310 mm	€ 16,00	€ 11,20
U03820008	500 g	320 mm	€ 18,00	€ 12,60
U03820009	600 g	330 mm	€ 20,80	€ 14,50
U03820010	800 g	350 mm	€ 24,10	€ 16,90
U03820011	1000 g	360 mm	€ 27,10	€ 19,00
U03820013	1500 g	380 mm	€ 36,30	€ 25,30
U03820014	2000 g	400 mm	€ 47,00	€ 32,90

Testa in acciaio al carbonio forgiata e sottoposta a trattamento termico differenziato per garantire una maggiore durata ed evitare scheggiature o ricalcature della superficie battente.

**UNI 7777
DIN 6475**

382

Martelli per meccanici

- Modello tedesco a testa quadra piana e penna simmetrica.
- Manico in frassino.



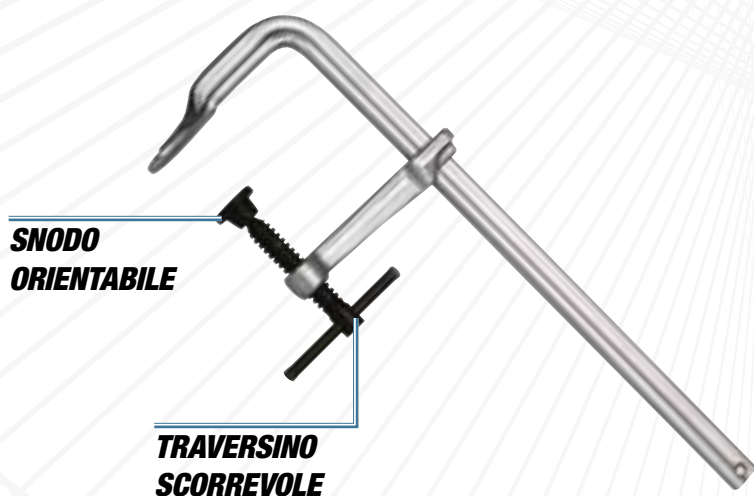

**SNODO
ORIENTABILE**

**TRAVERSINO
SCORREVOLE**

997 A

Strettoio a vite

- Corpo e asta scorrevole in acciaio forgiato.

CODICE	APERTURA	SEZIONE	PESO		
U09970002	160 mm	16x7,5 mm	0,5 kg	€ 28,20	€ 19,70
U09970003	200 mm	19,5x9,5 mm	0,9 kg	€ 35,10	€ 24,60
U09970004	250 mm	22x10,5 mm	1,2 kg	€ 42,10	€ 29,50
U09970005	300 mm	25x12 mm	1,8 kg	€ 53,50	€ 37,40
U09970006	400 mm	25x12 mm	1,9 kg	€ 56,00	€ 39,20
U09970007	500 mm	25x12 mm	2,1 kg	€ 61,00	€ 42,70
U09970008	600 mm	25x12 mm	2,3 kg	€ 66,00	€ 46,20
U09970009	800 mm	27x13 mm	3,3 kg	€ 86,50	€ 60,50
U09970010	1000 mm	27x13 mm	3,7 kg	€ 98,00	€ 68,50

997 B

Strettoio rapido a leva

- Regolazione e sgancio rapidi tramite leva e pulsante integrato.
- Corpo e asta scorrevole in acciaio forgiato.

CODICE	APERTURA	SEZIONE	PESO		
U09970013	120 mm	13,5x6,5 mm	0,7 kg	€ 53,50	€ 37,40
U09970014	160 mm	16x7,5 mm	1 kg	€ 59,00	€ 41,30
U09970015	200 mm	19,5x9,5 mm	1,3 kg	€ 71,50	€ 50,00
U09970016	250 mm	22x10,5 mm	1,9 kg	€ 83,00	€ 58,00
U09970017	300 mm	25x12 mm	2,7 kg	€ 102,00	€ 71,50
U09970018	400 mm	25x12 mm	2,8 kg	€ 107,00	€ 75,00
U09970019	500 mm	25x12 mm	3 kg	€ 112,00	€ 78,50

**PIANO
REGOLABILE**

**LEVA CON PULSANTE
DI SGANCIO INTEGRATO**

**10
PEZZI**



PER GHIERE CON DIAMETRI DA 20 A 100 mm

Ghiere con fori
sulla parte superiore



Ghiere con intagli
sulla parte superiore

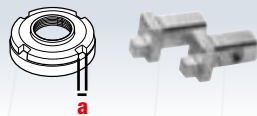

282 S10 U02820200

2 kg | 330 mm | 60 | 215

Assortimento in cassetta di ABS con chiavi a compasso per ghiera a nasello tondo e quadro

- Chiavi a compasso per ghiera con fori e con intagli.
- Le chiavi si regolano agendo sulla vite centrale.
- Naselli amovibili.
- Diametri ghiera: da 20 a 100mm.
- Finitura cromata satinata.
- Cassetta in ABS ad alta resistenza con sistema di chiusura a clip.

DESCRIZIONE	MISURA	PZ.
Naselli tondi	(d) 2,5 - 3 - 4 - 5 - 6 - 7 - 8 - 9 mm	4
Naselli quadri	(a) 4 - 5 - 6 - 8 mm	4

~~€ 161,00~~

€ 112,00

DIN 338

HSS-G

14
PEZZI



988 LA/S14

U09880070

Assortimento di punte e maschi

- Ø punte: 2,5-3,3-4,2-5,0-6,8-8,5-10,2 mm.
- M maschi: 3x0,5-4x0,7-5x0,8-6x1-8x1,25-10x1,5-12x1,75 mm.

~~€ 88,00~~

€ 61,50

DIN 338

HSS-G

19
PEZZI



988 MA/S19

U09880073

Assortimento di punte

- Ø punte: 1,0-1,5-2,0-2,5-3,0-3,5-4,0-4,5-5,0-5,5-6,0-6,5-7,0-7,5-8,0-8,5-9,0-9,5-10,0 mm.

~~€ 53,50~~

€ 37,40

DIN 338

HSS-G

25
PEZZI



988 MA/S25

U09880074

Assortimento di punte

- Ø punte: 1,0-1,5-2,0-2,5-3,0-3,5-4,0-4,5-5,0-5,5-6,0-6,5-7,0-7,5-8,0-8,5-9,0-9,5-10,0-10,5-11,0-11,5-12,0-12,5-13,0 mm.

~~€ 106,00~~

€ 74,00



HSS

3
PEZZI



988 D/S3

U09880020

Serie di 3 frese a scalino

ART.	Ø SCALINI	Ø CODOLO	LUNG.
988 D1	4-5-6-7-8-9-10-11-12 mm	6 mm	65 mm
988 D2	4-6-8-10-12-14-16-18-20 mm	8 mm	75 mm
988 D3	4-6-8-10-12-14-16-18-20-22-24-26-28-30 mm	10 mm	100 mm

~~€ 196,00~~

€ 138,00

HSS

12
PEZZI



988 G/S12

U09880100

Serie di 10 seghe a tazza bimetalliche

- Ø 19-22-25-29-35-38-44-51-57-64 mm.
- Profondità di taglio max: 38 mm.

~~€ 202,00~~

€ 141,00

HSS

10
PEZZI



Ø 6 mm



988 E/S10

U09880062

Frese rotative in metallo duro

- N°8 pezzi (Ø 10 e 12 forme EA-EC-EF-EG).
- N°2 pezzi (Ø 12 forme ED-EM).

~~€ 496,00~~

€ 230,00



YouTube



SMD
LED



COB
LED



1 = 18 h
2 = 3,6 h
3 = 1,8 h



Li-ion

RICARICABILE



USB-C



YouTube



SMD
LED



COB
LED



1 = 3 h
2 = 10 h
3 = 35 h



Li-ion

RICARICABILE



USB-C



YouTube



**Solo 91 mm
di lunghezza**



SMD
LED



IP54



1 = 18 h
2 = 3,6 h
3 = 1,8 h



Li-ion

RICARICABILE



USB-C

889 RL

U08890036

Lampada di ispezione a LED

~~€ 84,00~~

€ 59,00

DOPPIA FUNZIONE



LAMPADA



TORCIA

2 livelli di luminosità
(120 e 420 lumen)

889 IL

U08890046

Lampada di ispezione articolata a LED

~~€ 84,00~~

€ 59,00

TRIPLA FUNZIONE



TESTA



TORCIA



FRONTALE

889 GR

U08890044

Faretto compatto a LED

~~€ 113,00~~

€ 79,00

3 LIVELLI DI LUMINOSITÀ



50, 250 e 500 lumen con un semplice tocco.



Solo 94 mm di lunghezza



COB LED



IP20



1 = 1,5 h
2 = 3 h
3 = 3h



Li-ion

RICARICABILE



USB-C



Lampada COB LED



Torcia SMD LED



IP20



Li-ion



USB-A



COB LED



IP67



2,5 h



1 = 8 h
2 = 4 h
3 = 2,5 h



IK07



Li-ion



Clip di aggancio magnetico, orientabile a 360°

Corpo in alluminio

360°

180°



131 mm



160 mm

130 mm

FUNZIONA CON O SENZA CAVO!
Cavo da 5 metri incluso.

889 SP
U08890055

Torcia tascabile a LED

~~€ 42,70~~

€ 29,90



YouTube

DOPPIA FUNZIONE



150 LUMEN

Frontale



150 LUMEN

Torcia

889 RP
U08890045

Lampada a LED ricaricabile compatta

~~€ 68,50~~

€ 48,00



YouTube

DOPPIA FUNZIONE



180 LUMEN

Lampada



60 LUMEN

Torcia

889 RT
U08890038

Faretto a LED

~~€ 295,00~~

€ 207,00



YouTube

3 LIVELLI DI LUMINOSITÀ



MAX 1500 LUMEN

500, 1000 e 1500 lumen con un semplice tocco.

TRASFORMATORE INTEGRATO

Nessun alimentatore esterno.



YouTube

12 V 1200 A

10 kg 400 mm 320 115



1613 RA12

U16130019

Avviatore portatile 12V

- Scocca antiurto in ABS.
- Idoneo anche per batterie sigillate.

€ 583,00

€ 408,00

3500 A

Lunghezza cavi
155 cm

CONNETTORE POSTERIORE PER SELEZIONE VOLTAGGIO



12 V 1400 A
24 V 700 A

20,8 kg 560 mm 200 590



12V - 3700 A

1613 AGM12-24

U16130013

Avviatore professionale portatile 12V-24V

- Scocca antiurto in ABS.
- Protezione da sovratensione.

€ 1.322,00

€ 925,00

24V - 1860 A

Lunghezza cavi
155 cm



YouTube

POTENZA DI COMPRESSIONE

735 kg (6 bar), 1226 kg (10 bar).

447 T

U04470101

Smonta ammortizzatori pneumatico

- Ideale per autovetture.
- Fornito con due staffe inferiori 447 TC1 (78÷130 mm) e 447 TC2 (105÷182 mm), morsa 447 TA e morsetti superiori universali 447 TB1.

CARATTERISTICHE TECNICHE

Potenza compressione 735 kg (6 bar) - 1226 kg (10 bar)

Pressione di esercizio 6÷10 bar

Corsa del pistone 420 mm

Cilindro Doppio in lega d'alluminio e resina al nylon

60 kg 470 mm 1.390 450



€ 1.974,00

€ 1.381,00

Pressione regolabile FINO A 4 BAR

12 V

10 Litri

2847/3

U28470084

Spurgatore per circuito freni

- Permette di cambiare, riempire, spurgare i circuiti dei freni di autovetture e vecchi industriali.
- Apparecchio progettato esclusivamente per liquidi freno tipo DOT 3, DOT 4, DOT 5.1. No LHM.

CARATTERISTICHE TECNICHE

Sistema di manovra del liquido Pompa peristaltica (nessun contatto diretto pompa liquido, nessuna pressione aria sul liquido)

Alimentazione 12 V (morsetti batteria)

Capacità serbatoio 10 litri

Limitatore di pressione 4 bar

Tubo a spirale 4 m (elastico)

Cavo di alimentazione 4 m



Fornito con:

- guarnizioni di ricambio,
- 1 tappo multidiametro 44-45-46 mm (2847 N11).
- 1 contenitore di recupero olio.

€ 1.558,00

€ 1.091,00

PER BATTERIE 6÷12 V

Anche per sistema
Start & Stop



890 K
U08901000

Tester digitale per batterie con stampante

~~€ 697,00~~

€ 489,00



**IDEALE PER IMMETTERE
OLIO NEL DIFFERENZIALE**

**Non adatta per carburanti
e olii minerali**

1,5
Litri



421 P
U04210020

Siringa per olio

~~€ 70,00~~

€ 49,00

3
Litri

**IDEALE PER SPURGO
DEL LIQUIDO DEI
FRENI O FRIZIONE**

Pressione
di utilizzo
6÷10 bar



2847 A
U28470086

Spurgatore a depressione

~~€ 100,00~~

€ 70,00



YouTube



Compatibile
con termocoppia K.



1651
U16510001

Termometro digitale ad infrarossi

~~€ 189,00~~

€ 132,00

**IDEALE PER ASPIRAZIONE ED
EROGAZIONE DI OLIO, LIQUIDO
ANTIGELO E OLIO SERVOSTERZO**



421 M
U04210021

Siringa in metallo

~~€ 28,00~~

€ 19,60

9,5
Litri



4,1 kg | 230 mm | 627 | 302



1785 B
U17850005

Aspiratore liquidi
manuale e pneumatico

~~€ 231,00~~

€ 162,00



3 TON **30,5** kg



3t



2550 A
U25500001

Sollevatore idraulico 3T per auto e veicoli commerciali

- Struttura in acciaio.
- Portata elevata per utilizzo su auto, fuoristrada e furgoni.
- Sistema a doppia pompa per sollevare più velocemente la vettura.
- Dotato di comando di discesa manuale.
- Valvola di spurgo dell'aria, per evitare il pericolo di over-carico.

~~€ 347,00~~

€ 234,00



2 TON **32,5** kg



2t



2550 B
U25500002

Sollevatore idraulico 2T

- Struttura in acciaio.
- Per utilizzo in spazi ridotti.
- Sistema a doppia pompa per sollevare più velocemente la vettura.
- Dotato di pedale di avvicinamento.
- Dotato di comando di discesa manuale.
- Valvola di spurgo dell'aria, per evitare il pericolo di over-carico.

~~€ 490,00~~

€ 343,00

2 PEZZI

1950 C

Coppia colonnette

- Altezza regolabile tramite meccanismo dentato con rilascio a leva.
- Perno di bloccaggio con catena.
- 1950 C/3: modello regolabile a 10 posizioni.
- 1950 C/6: modello regolabile a 13 posizioni.



2000 A
U20000100

Letto sottoscocca 6 ruote

- Cuscino poggiatesta in vinile resistente agli idrocarburi.
- Struttura in materiale plastico resistente agli idrocarburi, lavabile.



~~€ 124,00~~

€ 87,00

CODICE PORT. H MAX H MIN DIMENSIONI PESO

U19501001 3 t 427 mm 300 mm 207x188 mm 7 kg ~~€ 96,50~~ **€ 67,50**

U19501002 6 t 620 mm 400 mm 285x250 mm 14 kg ~~€ 139,00~~ **€ 97,50**



3
PEZZI

1 1/2"

270 C/C3
U02700106

Assortimento in cassetta modulare con bussole macchina per cerchi in lega con protezione in téflon

~~€ 60,00~~

€ 42,00

↔ 190
↑ 58
↓ 144
mm

**È POSSIBILE RIPORLO
NEI CASSETTI DEI
NOSTRI CARRELLI**

Maniglia per il trasporto

230 g | 475
mm | 50
290



2000 G
U20000110

Tappeto per protezione ginocchia

~~€ 29,00~~

€ 20,30

YouTube
**VIDEO
TUTORIAL**



10
PEZZI

**KIT UNIVERSALE PER LA RIMOZIONE
DI DADI E VITI ANTIFURTO**

272 DS
U02720001



Kit estrazione dadi e viti antifurto

- Non danneggia il cerchio in lega.
- Punta speciale al carburo di tungsteno in grado di forare qualsiasi tipo di materiale (lubrificare con olio da taglio ad ogni utilizzo).
- Bussole coniche per centraggio/estrazione super sottili per accedere su ogni tipo di cerchio in lega.

~~€ 292,00~~

€ 204,00

Utilizzo manuale sui dadi ruota danneggiati

3
PEZZI

1 1/2"

XGRIP

235 1 1/2" XL/C3
U02354100

Assortimento in cassetta modulare con bussole lunghe con bocca esagonale speciale X-Grip

~~€ 30,00~~

€ 21,00

I VANTAGGI DEL PROFILO X-GRIP:

- Presa perfetta su esagoni nuovi e danneggiati fino all'80%.
- Trasmette una coppia superiore rispetto a una bussola standard.
- Non danneggia gli esagoni nuovi.



XGRIP



**Scopri tutte le
caratteristiche e
la gamma a pag. 4**

CHIAVE FILTRI OLIO 443 N CON REGOLAZIONE AUTOMATICA DEL NASTRO.

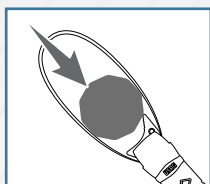

**SERRAGGIO AUTOMATICO
DEL NASTRO**

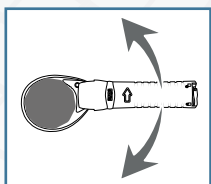

EFFETTO CRICCHETTO
Rapidità d'uso anche in spazi ridotti.

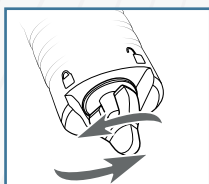

**LEVA DI INCREMENTO
POTENZA SERRAGGIO**



443 N
U04430005

Chiave automatica a
ripresa rapida per filtri
olio (autovetture)



**66÷105
mm**

~~€ 105,00~~

€ 73,50



YouTube

**6
PEZZI**

**3
8"**

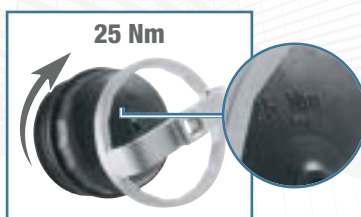

Permettono il riserraggio alla coppia
originale di smontaggio (valore indicato
sulla campana di plastica)

446 DA/SE6
U04461104

Serie di 6 chiavi per coperchio filtro olio

- 1 chiave 14 tacche Ø 76 mm.
- 1 chiave 14 tacche Ø 102 mm.
- 1 chiave 16 tacche Ø 76 mm.
- 1 chiave 16 tacche Ø 88 mm.
- 1 chiave 18 tacche Ø 66 mm.
- 1 chiave 18 tacche Ø 96 mm.
- Quadro di manovra 3/8".

~~€ 215,00~~

€ 151,00



Inquadra il QR code per scaricare la tabella
delle applicazioni o vai su usag.it

**3
8"**

**1
2"**

**30
PEZZI**



7 kg | 620 mm | 70 mm | 500

446 S28
U04461204

Assortimento di 30 chiavi per filtri olio

- Misure delle 28 chiavi a tazza Ø x N°lati:
66/6 - 65/14 - 65/67 - 68/14 - 73/14 - 74/15 -
74/76 - 75/77 - 76/12 - 76/14 - 76/30 - 76/8 -
78/15 - 80/15 - 80/82 - 86/16 - 86/18 -
90/15 - 92/10 - 93/15 - 93/36 - 93/45 - 95/15 -
96/18 - 100/15 - 106/15 - 108/15 - 108/18.

~~€ 204,00~~

€ 143,00

Inquadra il QR code per scaricare la tabella delle applicazioni o vai su usag.it



IN ALLUMINIO

446 DT/S2

U04461203

Serie di 2 chiavi per coperchi filtro olio modelli giapponesi

- Riduce i rischi di danneggiamento dei coperchi filtri.
- Utilizzabili anche in serraggio con chiave dinamometrica.



2
PEZZI

~~€ 60,50~~

€ 42,30

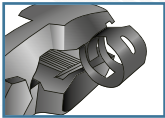

2 in 1

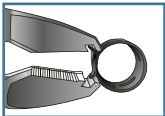

871 D

U08710001



Pinza per anelli stringitubo a presa frontale/laterale

- Possibilità di aggancio frontale o laterale.
- Ganasce con superficie di presa zigrinata.

~~€ 54,50~~

€ 38,20

3 posizioni di lavoro



871 C

U08719005P

Pinza per fascette automatiche CLIC

- Testa triassiale per lavorare in tutte le posizioni.
- Permette di aprire o chiudere le fascette automatiche presenti sui circuiti del carburante, dei collettori d'aspirazione e dei circuiti idraulici.

~~€ 77,50~~

€ 54,00

Inquadra il QR code per scaricare la tabella delle applicazioni o vai su usag.it



Attacco per il recuperatore d'olio

16
PEZZI

3/8

263/S16

U02631400

Kit per tappi olio

- Bussole magnetiche.
- 1 chiave snodata con coppetta.
- 2 inserti ○ 8-10 mm.
- 6 inserti ○ 8-10-12-13-14-17 mm.
- 6 bussole ● 13-14-17-18-19-21 mm.
- 1 inserto ○ T45.

~~€ 190,00~~

€ 133,00



Vaschetta raccogli olio integrata

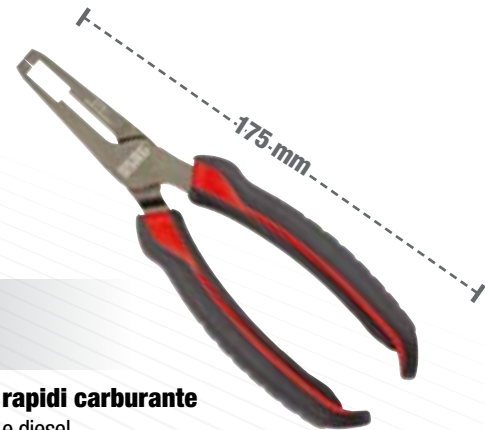

870 C

U08700006

Pinza per raccordi rapidi carburante

- Per veicoli a benzina e diesel.
- Impugnature ergonomiche bimalteriali.

~~€ 65,50~~

€ 46,00



22
PEZZI



1881 S22

U18810082

Kit universale per lo smontaggio e il montaggio delle ghiera pulegge alternatori

- Fornito in cassetta di plastica

~~€ 139,00~~

€ 97,00



2 MODALITÀ:

- 1 250 l/min - 50°÷400°C
- 2 500 l/min - 50°÷600°C

MAX
600
GRADI

2000
WATT

391
U03910001

Pistola termica digitale

- Modello elettronico con controllo della temperatura e del volume d'aria mediante display digitale.
- Possibilità di impostazione dei programmi.
- Dotata di sistema di raffreddamento.

~~€ 214,00~~

€ 93,00

Accessori inclusi

5
PEZZI

Per la rimozione di modanature, pioli, parti di cruscotto, rivestimenti portiere, etc.



426 B/S5
U04260006

Kit di 5 utensili per componenti in plastica

~~€ 32,10~~

€ 22,50

4
PEZZI

Per separare i carter della cinghia di distribuzione, testata motore, cinghia di trasmissione etc.



426 D/S4
U04260005

Kit di 4 scalpelli separatori in plastica

~~€ 27,50~~

€ 19,20



CARATTERISTICHE TECNICHE

Attacco filettatura	M18
Livello sonoro	78 Db
Lunghezza totale	610 mm
Peso	4 Kg
Pressione di esercizio	6,2 bar
Attacco filettato	1/4"

400 P
U04000010

Aspiratore pneumatico ammaccature

- Ideale per eliminare ammaccature da parti scatolate senza la necessità di rivernicare.
- Fornito con 3 ventose (Ø 75-100-125 mm), in valigetta in materiale plastico dotata di maniglia per il trasporto e clip di chiusura.

~~€ 206,00~~

€ 144,00

4
PEZZI

Per la rimozione di contrappesi, silicone, modanature etc



426 C/S4
U04260007

Kit di 4 raschietti multiuso in plastica

~~€ 34,20~~

€ 24,00

2
PEZZI

115 CL/SE2
U01150022

Serie di 2 pinze lunghe becchi diritti e piegati a 45°

- Ideale per la presa di pezzi e parti in posizioni di difficile accesso.

~~€ 81,50~~

€ 57,00



Serraggi controllati utilizzando cricchetti o chiavi a T

1/2"



YouTube

814 A

Dispositivo digitale coppia-angolo

- Permette serraggi coppia ed angolo di precisione digitale anche con utensili tradizionali.
- Per serraggi destrorsi e sinistrorsi.
- Scala di lettura in Nm/ft.lb/in-lb/kg.cm/gradi.
- Doppia indicazione: luminosa (LED) e sonora (buzzer) al raggiungimento del valore impostato.
- 9 valori di coppia o angolo preimpostabili.
- 50 misurazioni memorizzabili.
- In custodia di ABS con certificato di taratura.
- Alimentazione: 2 batterie AAA (incluse).

CODICE	CAPACITÀ	✓	RISOL.	€ 266,00	€ 187,00
U08140003	6,8÷135 Nm	1/2"	0,1	€ 306,00	€ 214,00
U08140004	10÷200 Nm	1/2"	0,1	€ 372,00	€ 261,00
U08140005	17÷340 Nm	1/2"	0,1		

Misurazione corretta dell'angolo in qualsiasi posizione

PRECISIONE ±2%



YouTube

831 A

U08310001

Goniometro digitale

- Permette serraggi angolari di precisione digitale in totale semplicità.
- Per serraggi destrorsi e sinistrorsi.
- Precisione angolo: +/- 2%.
- Scala: 0÷360°.
- Risoluzione: 0,1°.
- Doppia indicazione: luminosa (LED) e sonora (buzzer) al raggiungimento del valore impostato.
- 9 valori di angolo preimpostabili.
- 50 misurazioni memorizzabili.
- Fornito in custodia di ABS con certificato di taratura.
- Alimentazione: 2 batterie AAA (incluse nella confezione).

~~€ 193,00~~

€ 126,00

9 PEZZI

Due spazzole metalliche Ø 20mm e 25mm



885 F

U08850004

Kit pulizia iniettori

- Ideale per la pulizia del condotto degli iniettori montati su motori common rail.

~~€ 173,00~~

€ 121,00

6 PEZZI

1/2"



884 C/S6

U08841000

Serie di 6 chiavi per raccordi tubi iniettori

- Per montaggio/smontaggio dei raccordi tubi iniettori.
- Lunghezza: 98 mm.
- Misure: 12-14-16-17-18-19 mm.

~~€ 129,00~~

€ 90,50

ILLUMINAZIONE A LED

1/2"

1.898 Nm

2,2 kg



YouTube

CARTER IN LEGA DI MAGNESIO



TOP DI GAMMA

943 PC1 1/2"

U09430001

Avvitatore ad impulsi in magnesio

CARATTERISTICHE TECNICHE

Attacco quadro	1/2"	Pressione aria raccomandata	6,2 bar
Capacità bullone	M20	Pressione sonora	94 ±3 dB(A)
Coppia massima	1.898 Nm	Potenza sonora	105 ±3 dB(A)
Coppia di lavoro	320÷460 Nm	Vibrazioni	6,4 m/s ²
Impulsi al minuto	1200	Attacco aria	1/4"
Velocità a vuoto	6.500 giri/min	Diametro interno tubo aria	10 mm
Consumo medio aria	172 l/min	Peso	2,2 kg

€ 513,00

€ 352,00

IL RIFERIMENTO

929 PC1 1/2"

U09290001

Avvitatore ad impulsi in magnesio

CARATTERISTICHE TECNICHE

Attacco quadro	1/2"	Pressione aria raccomandata	6,2 bar
Capacità bullone	M16	Pressione sonora	93 ±3 dB(A)
Coppia massima	1.600 Nm	Potenza sonora	104 ±3 dB(A)
Coppia di lavoro	280÷440 Nm	Vibrazioni	6,2 m/s ²
Impulsi al minuto	1.300	Attacco aria	1/4"
Velocità a vuoto	7.000 giri/min	Diametro interno tubo aria	10 mm
Consumo medio aria	172 l/min	Peso	2,0 kg

€ 395,00

€ 267,00

EXTRA COMPATTO

942 PC3 1/2"

U09420012

Avvitatore ad impulsi - extra compatto

CARATTERISTICHE TECNICHE

Attacco quadro	1/2"	Pressione aria raccomandata	6,2 bar
Capacità bullone	M16	Pressione sonora	91,1±3 dB(A)
Coppia massima	861 Nm	Potenza sonora	108,1±3 dB(A)
Coppia di lavoro	150÷220 Nm	Vibrazioni	9,57 m/s ²
Impulsi al minuto	1650	Attacco aria	1/4"
Velocità a vuoto	10.000 giri/min	Diametro interno tubo aria	10 mm
Consumo medio aria	127 l/min	Peso	1,3 kg

€ 255,00

€ 181,00

CARTER IN LEGA DI MAGNESIO

1/2"

1.600 Nm

2 kg



YouTube



11 cm

1/2"

861 Nm

1,3 kg



YouTube



YouTube



Modulare con i cassetti dei carrelli USAG



Modulare con i cassetti dei carrelli USAG



Modulare con i cassetti dei carrelli USAG

943 PC1/C12 U09430005

→ 415
↓ 92
mm ↗ 283

1/2"

12
PEZZI



Assortimento in cassetta modulare con avvitatore ad impulsi e bussole macchina

DESCRIZIONE	ART./MISURA	PZ.
Avvitatore ad impulsi in magnesio	943 PC1 1/2	1
Chiavi a bussola macchina con bocca esagonale	235 1/2 M/ 10-13-17-18-19-22-24-27-30-32 mm	10
Spina di tenuta	235 MCA/4-6	2
Anello di sicurezza	235 MDA/4-6	2
Prolunghe macchina	236 1/2 M/125	1

~~€ 688,00~~

€ 427,00

929 PC1/C12 U09290005

→ 415
↓ 92
mm ↗ 283

1/2"

12
PEZZI



Assortimento in cassetta modulare con avvitatore ad impulsi e bussole macchina

DESCRIZIONE	ART./MISURA	PZ.
Avvitatore ad impulsi in magnesio	929 PC1 1/2	1
Chiavi a bussola macchina con bocca esagonale	235 1/2 M/ 10-13-17-18-19-22-24-27-30-32 mm	10
Spina di tenuta	235 MCA/4-6	2
Anello di sicurezza	235 MDA/4-6	2
Prolunghe macchina	236 1/2 M/125	1

~~€ 570,00~~

€ 348,00

942 PC3/C7 U09420015

→ 375
↓ 80
mm ↗ 186

1/2"

7
PEZZI



Assortimento in cassetta modulare con avvitatore ad impulsi e bussole macchina

DESCRIZIONE	ART./MISURA	PZ.
Avvitatore ad impulsi - extra compatto	942 PC3 1/2	1
Chiavi a bussola macchina con bocca esagonale	235 1/2 M/ 13-17-19-21-22-24 mm	6
Spina di tenuta	235 MCA/4	1
Anello di sicurezza	235 MDA/4	1

~~€ 341,00~~

€ 232,00

ILLUMINAZIONE A LED

CARTER IN LEGA DI MAGNESIO

CORPO IN ALLUMINIO

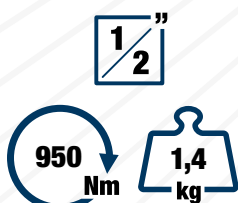

943 PC2 1/2"

U09430002

Avvitatore ad impulsi in magnesio con LED - Extra compatto

CARATTERISTICHE TECNICHE

Attacco quadro	1/2"	Pressione aria raccomandata	6,2 bar
Capacità bullone	M16	Pressione sonora	95±3 dB(A)
Coppia massima	950 Nm	Potenza sonora	107±3 dB(A)
Coppia di lavoro	200÷270 Nm	Vibrazioni	3,9 m/s ²
Impulsi al minuto	1400	Attacco aria	1/4"
Velocità a vuoto	10.000 giri/min	Diametro interno tubo aria	10 mm
Consumo medio aria	167 l/min	Peso	1,4 kg

€ 437,00

€ 306,00

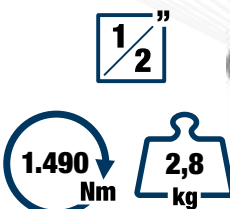

928 AC1 1/2"

U09280014

Avvitatore ad impulsi in alluminio

CARATTERISTICHE TECNICHE

Attacco quadro	1/2"	Pressione aria raccomandata	6,2 bar
Capacità bullone	M16	Pressione sonora	90 ±3 dB(A)
Coppia massima	1.490 Nm	Potenza sonora	101 ±3 dB(A)
Coppia di lavoro	135÷380 Nm	Vibrazioni	5,2 m/s ²
Impulsi al minuto	1.120	Attacco aria	1/4"
Velocità a vuoto	6.500 giri/min	Diametro interno tubo aria	10 mm
Consumo medio aria	147 l/min	Peso	2,8 kg

€ 313,00

€ 213,00

CARTER IN LEGA DI TITANIO

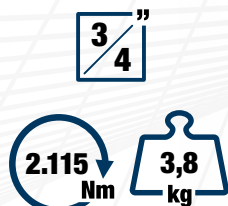

942 PD1 3/4"

U09420004

Avvitatore ad impulsi in titanio

CARATTERISTICHE TECNICHE

Attacco quadro	3/4"	Pressione aria raccomandata	6,2 bar
Capacità bullone	M27	Pressione sonora	97,8±3 dB(A)
Coppia massima	2.115 Nm	Potenza sonora	108,8±3 dB(A)
Coppia di lavoro	500÷800 Nm	Vibrazioni	5,06 m/s ²
Impulsi al minuto	950	Attacco aria	3/8"
Velocità a vuoto	5.300 giri/min	Diametro interno tubo aria	10 mm
Consumo medio aria	200 l/min	Peso	3,8 kg

€ 916,00

€ 641,00

CORPO IN ALLUMINIO

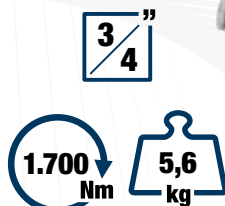

928 D1 3/4"

U09280015

Avvitatore ad impulsi in alluminio

CARATTERISTICHE TECNICHE

Attacco quadro	3/4"	Pressione aria raccomandata	6,2 bar
Capacità bullone	M24	Pressione sonora	98,4±3 dB(A)
Coppia massima	1.700 Nm	Potenza sonora	109,4±3 dB(A)
Coppia di lavoro	500÷1.050 Nm	Vibrazioni	9,1 m/s ²
Impulsi al minuto	790	Attacco aria	3/8"
Velocità a vuoto	5.700 giri/min	Diametro interno tubo aria	13 mm
Consumo medio aria	193 l/min	Peso	5,6 kg

€ 834,00

€ 584,00

CORPO IN COMPOSITO

**MANIGLIA
ERGONOMICA
BIMATERIALE**

1"

3.390
Nm

6,8
kg

**LEGGERO E
POTENTE**

- 20% di peso
rispetto allo standard



942 PE1 1"

U09420005

Avvitatore ad impulsi in materiale composito

CARATTERISTICHE TECNICHE

Attacco quadro	1"
Capacità bullone	M38
Coppia massima	3.390 Nm
Coppia di lavoro	203÷1.627 Nm
Impulsi al minuto	900
Velocità a vuoto	5.000 giri/min
Consumo medio aria	400 l/min
Pressione aria raccomandata	6,2 bar
Pressione sonora	100,9 ±3 dB(A)
Potenza sonora	111,9 ±3 dB(A)
Vibrazioni	10,6 m/s ²
Attacco aria	1/2"
Diametro interno tubo aria	19 mm
Peso	6,8 kg

~~€ 1.118,00~~

€ 783,00

910 E1 1"

U09100020

Avvitatore ad impulsi in alluminio

CARATTERISTICHE TECNICHE

Attacco quadro	1"
Capacità bullone	M33
Coppia massima	4.068 Nm
Coppia di lavoro	850÷1.300 Nm
Impulsi al minuto	720
Velocità a vuoto	4.500 giri/min
Consumo medio aria	243 l/min
Pressione aria raccomandata	6,2 bar
Pressione sonora	102 ±3 dB(A)
Potenza sonora	113 ±3 dB(A)
Vibrazioni	15,2 m/s ²
Attacco aria	1/2"
Diametro interno tubo aria	13 mm
Peso	10,3 kg

~~€ 1.502,00~~

€ 999,00

CORPO IN ALLUMINIO

1"

4.068
Nm

10,3
kg



152 mm

5 mm

105 l/min

COMPATTA

221 mm



920 AN1

U09200011

Levigatrice roto-orbitale

CARATTERISTICHE TECNICHE

Potenza	0,19 Kw
Capacità disco	Ø 152 mm
Orbita	5 mm
Orbite al minuto	10.000 giri/min
Consumo medio aria	105 l/min
Pressione aria raccomandata	6,2 bar
Pressione sonora	78,9±3 dB(A)
Potenza sonora	79,9±3 dB(A)
Vibrazioni	11,8 m/s ²
Attacco aria	1/4"
Diametro interno tubo aria	10 mm
Peso	0,8 kg



€ 332,00

€ 232,00



125 mm

750 W

12.000 Giri/min

921 A4

U09210012

Smerigliatrice angolare

CARATTERISTICHE TECNICHE

Diametro disco	Ø 125 mm
Diametro attacco disco	Ø 24 mm
Potenza	0,75 Kw
Velocità a vuoto	12.000 giri/min
Consumo medio aria	120 l/min
Pressione aria raccomandata	6,2 bar
Pressione sonora	86±3 dB(A)
Potenza sonora	94±3 dB(A)
Vibrazioni	2,5 m/s ²
Attacco aria	1/4"
Peso	1,9 Kg



€ 332,00

€ 232,00

1/2"

136 Nm

1,2 kg

260 mm



913 PC2 1/2"

U09130017

Cricchetto in materiale composito

CARATTERISTICHE TECNICHE

Attacco quadro	1/2"	Pressione sonora	99±3 dB(A)
Capacità bullone	M10	Potenza sonora	110±3 dB(A)
Coppia massima	136 Nm	Vibrazioni	9,1 m/s ²
Velocità a vuoto	280 giri/min	Attacco aria	1/4"
Consumo medio aria	113 l/min	Diametro interno tubo aria	10 mm
Pressione aria raccomandata	6,2 bar	Peso	1,2 kg

€ 249,00

€ 175,00

CAVO 16 m
Ø 10 mm

939 C1

U09390004

Avvolgitubo aria

CARATTERISTICHE TECNICHE

Lunghezza tubo	16 m
Diametro interno tubo	10 mm
Pressione max di utilizzo	15 bar
Raccordo in uscita	3/8"
Dimensioni (inclusa staffa)	450x400x230 mm
Peso	8 kg



€ 331,00

€ 232,00

GAMMA SMERIGLIATRICI PNEUMATICHE

**CORPO ED IMPUGNATURA IN
MATERIALE ANTISCIVOLO**

**LEVA DI SICUREZZA
A SCATTO**

PINZA DA 6 mm

**SISTEMA A DOPPIO
CUSCINETTO PER UNA
MAGGIORE DURATA**

**SCARICO ARIA
POSTERIORE**

**ATTACCO FILETTATO
DA 1/4"**



YouTube

30.000 Giri/min

**0,3 CV
220 W**

**Ø 6
mm**

**76
l/min**



922 B1
U09220001

Smerigliatrice dritta

CARATTERISTICHE TECNICHE

Consumo medio aria	76 l/min	Vibrazioni	2,42 m/s ²
Pressione aria raccomandata	6,2 bar	Attacco aria	1/4"
Pressione sonora	84,8±3 dB(A)	Diametro interno tubo aria	10 mm
Potenza sonora	99,5±3 dB(A)	Peso	440 g

~~€ 116,00~~

€ 69,00

23.000 Giri/min

**0,3 CV
220 W**

**Ø 6
mm**

**76
l/min**



922 BP1
U09220004

Smerigliatrice angolare 90°

CARATTERISTICHE TECNICHE

Consumo medio aria	76 l/min	Vibrazioni	4,54 m/s ²
Pressione aria raccomandata	6,2 bar	Attacco aria	1/4"
Pressione sonora	85,9±3 dB(A)	Diametro interno tubo aria	10 mm
Potenza sonora	96,9±3 dB(A)	Peso	555 g

~~€ 165,00~~

€ 115,00

28.000 Giri/min

**0,3 CV
220 W**

**Ø 6
mm**

**76
l/min**



922 BL1
U09220003

Smerigliatrice mandrino lungo

CARATTERISTICHE TECNICHE

Consumo medio aria	76 l/min	Vibrazioni	2,86 m/s ²
Pressione aria raccomandata	6,2 bar	Attacco aria	1/4"
Pressione sonora	83,3±3 dB(A)	Diametro interno tubo aria	10 mm
Potenza sonora	94,3±3 dB(A)	Peso	664 g

~~€ 165,00~~

€ 115,00



16
PEZZI

1/2"

1/2" **5/16"**

↔ 210
↓ 60
mm ↗ 130

687 1/2" C16

U06870100



Assortimento in cassetta di ABS con inserti macchina

DESCRIZIONE	ART./MISURA	PZ.
Portainseri	685 6 1/2	1
Portainseri	685 8 5/16	1
Inseri esagono maschio 1/2	687 E 6-7-8-10-12-14	6
Inseri TORX 1/2	687 TX T30-T40-T45-T50-T55	5
Inseri PHILLIPS 5/16	686 PH 2-3-4	3

~~€ 197,00~~

€ 106,00



16
PEZZI

1/2"

↔ 375
↓ 80
mm ↗ 186

235 1/2" M/C16

U02359285



Assortimento in cassetta modulare con bussole macchina esagonali

DESCRIZIONE	ART./MISURA	PZ.
Chiavi a bussola macchina con bocca esagonale	235 1/2 M 10-12-13-14-15-16-17-18-19-21-22-24-27-30-32 mm	15
Spina di tenuta	235 MCA/4-6	2
Anello di sicurezza	235 MDA/4-6	2
Prolunghe macchina	236 1/2 M/125	1

~~€ 234,00~~

€ 117,00



6
PEZZI

3/4" **7/8"**

↔ 210
↓ 60
mm ↗ 130

688 3/4" MD6

U06880010



Assortimento in cassetta di ABS con inserti macchina

DESCRIZIONE	ART./MISURA	PZ.
Portainseri	685 B 1 7/8	1
Inseri esagono maschio 7/8	688 E 12-17-19-22-24	5

~~€ 232,00~~

€ 159,00



8
PEZZI

3/4"

↔ 375
↓ 80
mm ↗ 186

235 3/4" M/C8

U02359286



Assortimento in cassetta modulare con bussole macchina esagonali

DESCRIZIONE	ART./MISURA	PZ.
Chiavi a bussola macchina con bocca esagonale	235 3/4" M 21-22-24-27-30-32-36-41 mm	8

~~€ 240,00~~

€ 127,00

BUSSOLE MACCHINA RIBASSATE 235 MB



1 1/2"
10
PEZZI

→ 190
↓ 58
mm ↗ 144



1 1/2"

1 1/2"

22
PEZZI

→ 415
↓ 92
mm ↗ 283

235 1/2" MB/C10
U02350530

Assortimento in cassetta modulare con bussole macchina esagonali ribassate

DESCRIZIONE	ART./MISURA	PZ.
Chiavi a bussola macchina ribassate esagonali	235 1/2" M 10-11-12-13-14-15-16-17-18-19	10

~~€ 91,50~~

€ 59,00

236 KE/C22
U02360900



Assortimento in cassetta modulare con bussole macchina esagonali ribassate, prolunga a catena, inserti e accessori

DESCRIZIONE	ART./MISURA	PZ.
Chiavi a bussola macchina ribassate esagonali	235 1/2" MB 13-14-15-16-17-18-19	7
Prolunga a catena	236 KE 1/2"	1
Inserti macchina esagonali	687 E 5-6-8-10-12-14	6
Inserti macchina TORX	687 TX T25-T27-T30-T40-T45-T50-T55	7
Adattatore per bussole	236 KEADP	1

~~€ 387,00~~

€ 199,00

**UTILIZZABILI CON
AVVITATORE AD IMPULSI**

236 K
per bussole



YouTube



YouTube



236 KE
per inserti

MASSIMA ACCESSIBILITÀ
DIMENSIONI TESTA COME UN
CRICCHETTO*.



39 mm

*Confronto con cricchetto da 1/2".

MINIMO INGOMBRO
INNESTO DIRETTO PER
INSERTI MACCHINA.



Anello di tenuta
in acciaio integrato.

236 K

1 1/2" **1 1/4"**

Prolunga a catena in alluminio per bussole

CODICE	□	L	H	🛒	
U02360700	1/2"	340 mm	39 mm	1,1 kg	€ 118,00 € 59,00
U02360698	1/4"	260 mm	27 mm	300 g	€ 89,00 € 49,00

236 KE

1 1/2" **1 1/2"** **1 1/4"** **1 1/4"**

Prolunga a catena in alluminio per inserti

CODICE	□	◊	L	H	🛒	
U02360705	1/2"	1/2"	340 mm	24 mm	1,1 kg	€ 118,00 € 59,00
U02360710	1/4"	1/4"	260 mm	19 mm	300 g	€ 89,00 € 49,00



**Iscriviti
al nostro canale
@USAGitalia**

Video tutorial,
novità di prodotto
e molto altro!

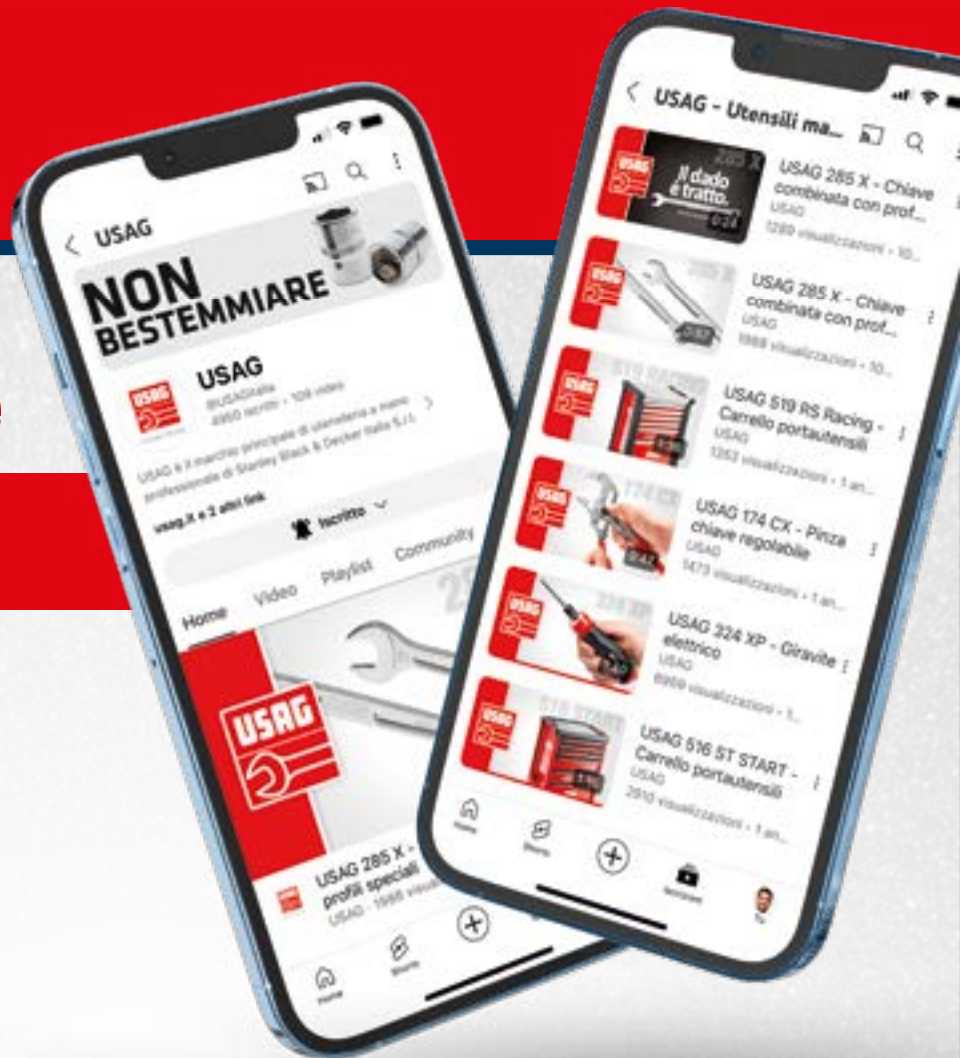

Sei un utilizzatore finale e vuoi contattarci?
Vai sul nostro sito:



usag.it/it/contacts/support



Oppure chiamaci: tel. 02.8295.3731 da Lunedì a Venerdì dalle 08:30 alle 19:30.

Offerta valida fino al 31 gennaio 2025 salvo esaurimento scorte, presso i Rivenditori che aderiscono all'iniziativa.

Tutti i prezzi sono da intendersi in Euro, IVA esclusa. Le immagini riprodotte in questa brochure sono indicative. Stanley Black & Decker Italia S.r.l. si riserva in ogni momento di modificare le caratteristiche tecniche dei prodotti.



Stanley Black & Decker Italia S.r.l.

Sede operativa:
Via Volta, 3 - 21020 - Monvalle (VA)
Tel. +39 0332 790 111 - info.mv@usag.it

usag.it

